

Quality Products, Prompt Service, Trustful Relationships.

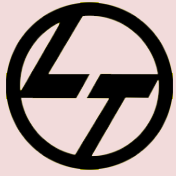

SIEMENS



OMRON



ABB

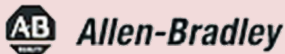

KM Industrial Corporation has established itself as a trusted supplier of **Electrical, Machinery and Industry Goods** for the last 23 years. We supply to various industries including but not limited to Power generation plants, Cement Plants, Rolling mills, Railways, Rubber Factories, Textile Mills, Construction Equipment Manufacturers, Oil Refineries, Hospitals, Hotels and Corporate across the country along with a strong market presence in **UAE, Saudi Arabia, Oman, US and Canada.**

We, at KMIC, assure our clients of **quality products** and excellent after sales service. This way we believe we sell peace of mind and help our clients focus on their core business. Some of our clients in various industrial areas in **India and Middle East** have been associated with us for more than **10 years now.**

Our superior knowledge of products and **excellent relationships** with clients remain our biggest strength and guiding force in our business.

We have large experience of working with big corporates in Oil & Gas & Construction companies in Middle East. We would be glad to have an association with you.

For details, Visit us at

[www.kmindustrialcorp.com](http://www.kmindustrialcorp.com)

### Leading Exporters of:

- **Control Panel Accessories**
- **Switchgears**
- **Contactors**
- **Relays**
- **MCBs**
- **Sensors**
- **Automation Drives**
- **DC Drives**
- **Electric Motors**
- **Timers**
- **Rotary Switches**
- **Fuses**
- **Power capacitors**
- **Indicating Lights**
- **Push buttons**
- **Wires and Cables**
- **Cable Lugs**
- **Cable Glands**
- **Energy Meters**
- **Motor Starters**
- **Motor Terminal Plates**
- **Slip rings**
- **All types of Carbons**
- **HOLDERS and Brushes**
- **Generator Spares**
- **Coils**
- **Ball Bearings**



**HAVELLS**

*Powering Lives...*



# **LV Switchgear, Controlgear & Power Quality Products**

Pricelist w.e.f. 11th March, 2024



## CONTENTS

### Controlgear

3 Pole Power Contactors	10
4 Pole, 2 Pole Power Contactors & Control Relay	11
Accessories - HGS Series Contactors	13
Thermal Overload Relay - HGST	14
Capacitor Duty Contactors	15
3 Pole DC, Mini Contactors & Control Relay	19
3 Pole DC, Mini Contactors Accessories	21
3 Pole DC, Mini Contactors Thermal Overload Relay	23
MPCB & Accessories - HGSM	26
MPCB & Accessories - HGSTM / HGSMR	27
Industrial Starter & Spares - HGS	31
Agri Starter - Urjalite DOL Starter, Urja DOL Starter	35
Urja DOL Submersible & ASD Submersible Starter	36
Powerguard - Single Phase Submersible Controller (STD & DLX)	37
Urja Contactor 4 P & 2 P, Thermal Overload Relay 3 P & 2 P	38
Spares & Accessories - Urja	39
Street Light Panel	42

### Powergear

Titania Air Circuit Breaker	47
HIM Moulded Case Circuit Breaker	56
Loadline Moulded Case Circuit Breaker	61
Loadline Microprocessor Moulded Case Circuit Breaker	64
PowerSafe Load Bank MCCB Panel Boards	67
Busbar Chamber	69
InstaShift Manual Changeover Switch	70
InstaShift Motorised Changeover Switch	70
Instaprime / Instaline Automatic Transfer Switch	71
Euroload Changeover Switch	72
Euroload By-Pass Changeover Switch	72
Euroload Switch Disconnecter	73
Kompact Switch Disconnecter Fuse	74
Hibreak Fuse Base	77
HBC Fuse Link	78

### Power Quality Solutions

Single Phase Capacitors	82
Cylindrical Capacitors (MPP Type)	83
Square Cap Capacitors (MPP Type)	84
HD Harmonic Detuned Reactors	88
IPFC Relay	89
Thyristor Switch	89
Capacitor Duty Contactor	90
APFC Panel	93
Active Harmonic Filter	94
Agri Boost Capacitors	97

# Fully Automated Plant

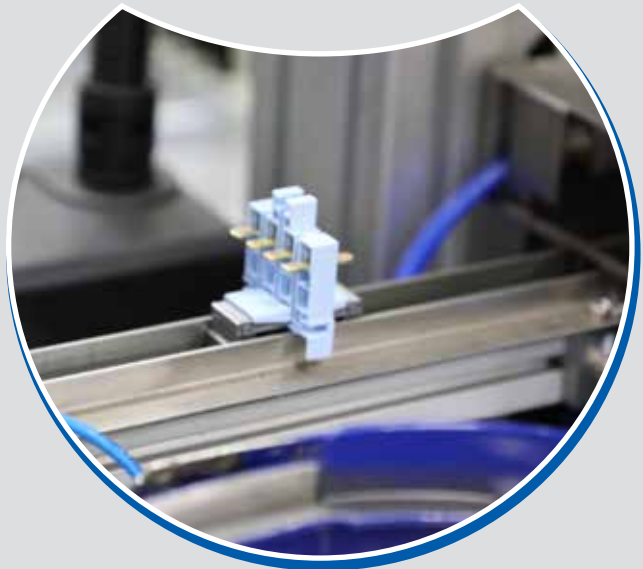

# Industry 4.0

Make in India, for India and for rest of the World



# Havells Global Series Magnetic Contactors, Overload Relays & MPCBs

Designed for demanding applications & Tropical conditions



# HGS - Trusted Global Range

## Contactors, Overload Relays & MPCBs

Motor Control Solutions for higher Safety, Reliability & Performance



HGS - 3 Pole Contactor  
Ratings - 9 A to 800 A (AC-3)



HGS - 4 Pole Contactor  
Ratings - 16 A to 60 A (AC-1)



HGS - 2 Pole Contactor  
Ratings - 9 A to 100 A (AC-3)



HGST - Thermal Overload Relay  
Ratings - 0.12 A to 800 A



Capacitor Duty Contactor  
Ratings - 3 kVAR to 66 kVAR



HGSCD - 3 Pole DC Contactor  
Ratings - 9 A to 105 A (AC-3)



HGSDR - Thermal Overload Relay  
Ratings - 0.28 A to 112 A



HGSCM -  
3 Pole Mini Contactor  
Ratings - 16 A (AC-1)



HGSMR -  
Thermal Overload Relay  
Ratings - 0.28 A to 17 A



Motor Protection  
Circuit Breaker  
Ratings - 0.1 A to 32 A



Motor Protection  
Circuit Breaker  
Ratings - 0.1 A to 63 A

# Contactor HGS 9 - 800 AF

3 Pole Power Contactors

Wide band Operating Coils

Finger proof IP 20 terminals

Suitable for AC-4 (Inching & Plugging, e.g. crane Duty) and other critical application

CE Marking & Compliance to IS/IEC 60947-4-1

High Electrical and Mechanical Durability with Higher operating frequency (Operations / Hour)

Electrical Durability Curves available

Low VA Burden coils with Class H Insulation

Dust free covers

Terminal Barrier and Shrouds

In-built Auxiliary Contacts

DIN Channel Mounting upto 100 A, Fr-4

## Contactor (HGS)



## Overload Relay (HGST)



**18 AF**

**40 AF**

**65 AF**

**100 AF**

**HGS  
Rated Current**

**Rated Operational  
Voltage**

9 A, 12 A, 18 A, 22 A  
690 V

25 A, 32 A, 40 A  
690 V

50 A, 65 A  
690 V

75 A, 85 A, 100 A  
690 V

**HGST  
Setting Current**

0.12 A - 18 A

7 A - 40 A

7 A - 65 A

17 A - 100 A

# Thermal Overload Relays HGST 9 - 800 AF



Overload Relays

Trip Class - 10 A

Automatic Reset / Manual Reset

Test Button for emergency stop

Phase loss Protection

Accelerated tripping on single phasing condition

IP20 terminals

Sealable Protection Cover

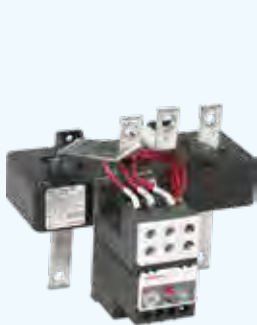

**150 AF**

**265 AF**

**500 AF**

**800 AF**

115 A, 130 A, 150 A  
1000 V

185 A, 225 A, 265 A  
1000 V

300 A, 400 A, 500 A  
1000 V

630 A, 800 A  
1000 V

48 A - 150 A

48 A - 265 A

90 A - 500 A

378 A - 800 A

# Magnetic Contactor

## 3 Pole Power Contactors



### Features:

- AC Coil up to Frame-4 and AC/DC Universal coil with SMART ECM (Electronic Control Module) in-built for Frame-5 to Frame-8
- Conforms to IS / IEC 60947-4-1
- Finger proof IP20 terminals
- Low VA Burden Wide operating band coils with Class H Insulation

HSN Code: 85369090

Frame Size	AC-3 Duty Rating at 415 V, 50 Hz	AC-1 Duty Rating at 415 V, 50 Hz	Power Poles	In-built Auxilliary Contacts		Type	Item Code	Per Unit LP (₹)
	I <sub>e</sub> A	I <sub>th</sub> A		NO	NC			
1	9 A	25 A	3	1	0	HGS 9	IHPHA009110*	1116.00
	9 A	25 A	3	0	1	HGS 9	IHPHA009101*	1116.00
	12 A	30 A	3	1	0	HGS 12	IHPHA012110*	1300.00
	12 A	30 A	3	0	1	HGS 12	IHPHA012101*	1300.00
	18 A	40 A	3	1	0	HGS 18	IHPHA018110*	1504.00
	18 A	40 A	3	0	1	HGS 18	IHPHA018101*	1504.00
	22 A	40 A	3	1	0	HGS 22	IHPHA022110*	1620.00
2	25 A	45 A	3	1	0	HGS 25	IHPHA025210*	1887.00
	25 A	45 A	3	0	1	HGS 25	IHPHA025201*	1887.00
	32 A	55 A	3	1	0	HGS 32	IHPHA032210*	3978.00
	32 A	55 A	3	0	1	HGS 32	IHPHA032201*	3978.00
	40 A	60 A	3	1	0	HGS 40	IHPHA040210*	5930.00
	40 A	60 A	3	0	1	HGS 40	IHPHA040201*	5930.00
3	50 A	70 A	3	2	2	HGS 50	IHPHA050300*	8013.00
	65 A	85 A	3	2	2	HGS 65	IHPHA065300*	10032.00
4	75 A	110 A	3	2	2	HGS 75	IHPHA075400*	12011.00
	85 A	125 A	3	2	2	HGS 85	IHPHA085400*	14158.00
	100 A	135 A	3	2	2	HGS 100	IHPHA100400*	20410.00
5	115 A	160 A	3	2	2	HGS 115	IHPHA115500*	25645.00
	130 A	180 A	3	2	2	HGS 130	IHPHA130500*	26401.00
	150 A	210 A	3	2	2	HGS 150	IHPHA150500*	32180.00
6	185 A	275 A	3	2	2	HGS 185	IHPHA185600*	37217.00
	225 A	315 A	3	2	2	HGS 225	IHPHA225600*	40453.00
	265 A	350 A	3	2	2	HGS 265	IHPHA265600*	45532.00
7	300 A	400 A	3	2	2	HGS 300	IHPHA300700*	55917.00
	400 A	500 A	3	2	2	HGS 400	IHPHA400700*	69920.00
	500 A	550 A	3	2	2	HGS 500	IHPHA500700*	100726.00
8	630 A	750 A	3	2	2	HGS 630	IHPHA630800*	157138.00
	800 A	900 A	3	2	2	HGS 800	IHPHA800800*	253534.00

\*To complete the Cat no. suffix the coil voltage from the coil voltage table  
 Note: 1. For additional aux. contacts front/side mounted and mechanical interlock - refer accessories table on page no. 13  
 2. Standard Spare coil are available on request on page no 13

ECM\* - Electronic Control Module  
 Note : For other coil voltages, Contact to nearest branch  
 To avoid Coil burning due to Neutral Floaring conditions, either use Wide band Coils or make use of 415 V Coils

Frame Size	AC Coil Codes for Nominal Voltage at 50/60 Hz					
	B	H	N	T	Wide Band Coils	
					S	W
1	24 V	110 V	240 V	415 V	150 V-300 V	260 V-440 V
2	24 V	110 V	240 V	415 V	150 V-300 V	260 V-440 V
3	24 V	110 V	240 V	415 V		260 V-440 V
4	24 V	110 V	240 V	415 V		260 V-440 V
			AC/DC Universal Coil with in-built ECM* Module 240 V N	AC Coil with in-built ECM* Module 415 V T		
5, 6, 7	-	100 V AC -240 V AC & 110 V DC -220 V DC		380 V AC - 450 V AC	-	-
8	-	200 V AC -240 V AC & 200 V DC -220 V DC		380 V AC - 450 V AC	-	-

# Magnetic Contactor

## 4 Pole Power Contactors with AC Coil



### Features:

- AC-1 Ratings up to 60 A
- Conforms to IS / IEC 60947-4-1
- Common Accessories with HGS Range
- Finger proof IP20 terminals
- Completely Shield for dusty atmosphere
- Low VA Burden Wide operating band coils with Class H Insulation

HSN Code: 85369090

Frame Size	AC 1 Duty	Power Poles	Item Code	Per Unit LP (₹)	Power Poles	Item Code	Per Unit LP (₹)
1	16	4NO	IHPHC016100*	1336.00	2NO + 2NC	IHPHC016122*	1471.00
	20	4NO	IHPHC020100*	1366.00	2NO + 2NC	IHPHC020122*	1504.00
	25	4NO	IHPHC025100*	1474.00	2NO + 2NC	IHPHC025122*	1669.00
	32	4NO	IHPHC032100*	1511.00	2NO + 2NC	IHPHC032122*	1730.00
	40	4NO	IHPHC040100*	2280.00	2NO + 2NC	IHPHC040122*	2462.00
2	50	4NO	IHPHC050200*	2977.00	2NO + 2NC	IHPHC050222*	3336.00
	60	4NO	IHPHC060200*	5677.00	2NO + 2NC	IHPHC060222*	6364.00

\*To complete the Cat no. suffix the coil voltage from the coil voltage table

Note: Coil S & W is not available for - 2 NO + 2 NC

# Magnetic Contactor

## Aux Contactor / Control Relay - HGS Series with AC Coil

### Features:

- Common Accessories with HGS Range
- Suitable for use upto 690 V AC
- Compliance to IEC 60947-5-1
- High Thermal current of  $I_{th} = 16$  A
- Finger proof IP20 terminals
- Low VA Burden Wide operating band coils with Class H Insulation



HSN Code: 85369090

Frame size	$I_{th}$	Contact arrangement		Type	Item Code	Per Unit LP (₹) with AC Coil
		NO	NC			
1	16 A	2	2	HGR 22	IHHAC22*	1075.00
		3	1	HGR 31	IHHAC31*	
		4	0	HGR 40	IHHAC40*	
		0	4	HGR 04	IHHAC04*	
		1	3	HGR 13	IHHAC13*	

\*To complete the Cat no. suffix the coil voltage from the coil voltage table

Note: Control relay is not available in wide band

# Magnetic Contactor

## HGS 2 Pole Contactor with AC Coil



### Features:

- Common Accessories with HGS Range
- Compliance to IEC 60947-4-1

HSN Code: 85369090

Frame Size	AC-3 Duty Rating at 415 V, 50 Hz		AC-1 Duty Rating at 415 V, 50 Hz	Power Poles	In-built Auxilliary Contacts		Item Code	Per Unit LP (₹)
	$I_e$ A	$I_{th}$ A			NO	NC		
1	9 A	25 A	25 A	2	0	0	IHPHF009100*	837.00
	12 A	30 A	30 A	2	0	0	IHPHF012100*	976.00
	18 A	40 A	40 A	2	0	0	IHPHF018100*	1128.00
	22 A	40 A	40 A	2	0	0	IHPHF022100*	1215.00
2	25 A	45 A	45 A	2	0	0	IHPHF025200*	1321.00
	32 A	55 A	55 A	2	0	0	IHPHF032200*	2786.00
	40 A	60 A	60 A	2	0	0	IHPHF040200*	4151.00
NEW 3	50 A	70 A	70 A	2	0	0	IHPHF050300*	5209.00
	65 A	85 A	85 A	2	0	0	IHPHF065300*	7550.00
NEW 4	75 A	110 A	110 A	2	0	0	IHPHF075400*	8650.00
	85 A	125 A	125 A	2	0	0	IHPHF085400*	10500.00
	100 A	135 A	135 A	2	0	0	IHPHF100400*	13500.00

Effective from 11th March, 2024

List Price (LP) are in Indian ₹ & as per Standard Terms & Conditions

**HAVELLS 11**

# Accessories

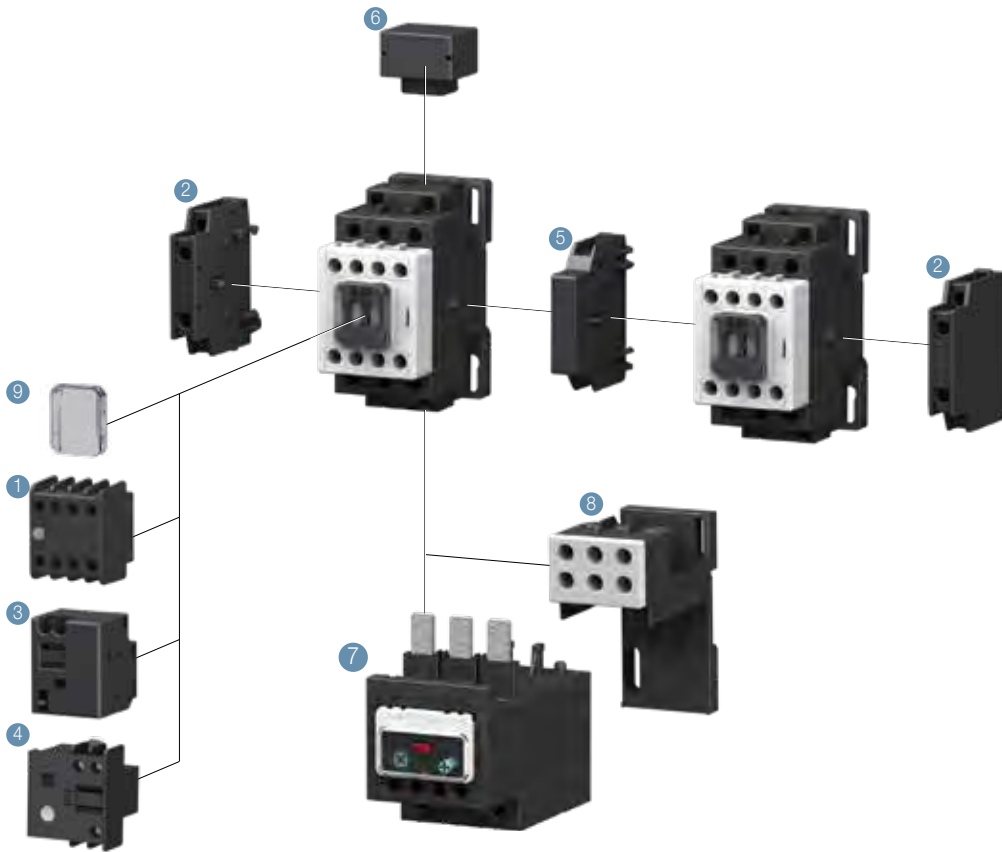

## 9 - 100 AF

- Auxiliary Contact Block (Front Side) HGS TB
- Auxiliary Contact Block (Left/Right Side) HGS SB
- Mechanical Latching Block HGS LB 100
- Timer HGS ET
- Interlock Unit HGS IU
- Surge Absorber HGS RC/CD
- Thermal Overload Relay HGST
- Separate Mounting Base HGSTMB
- Front Safety Cover

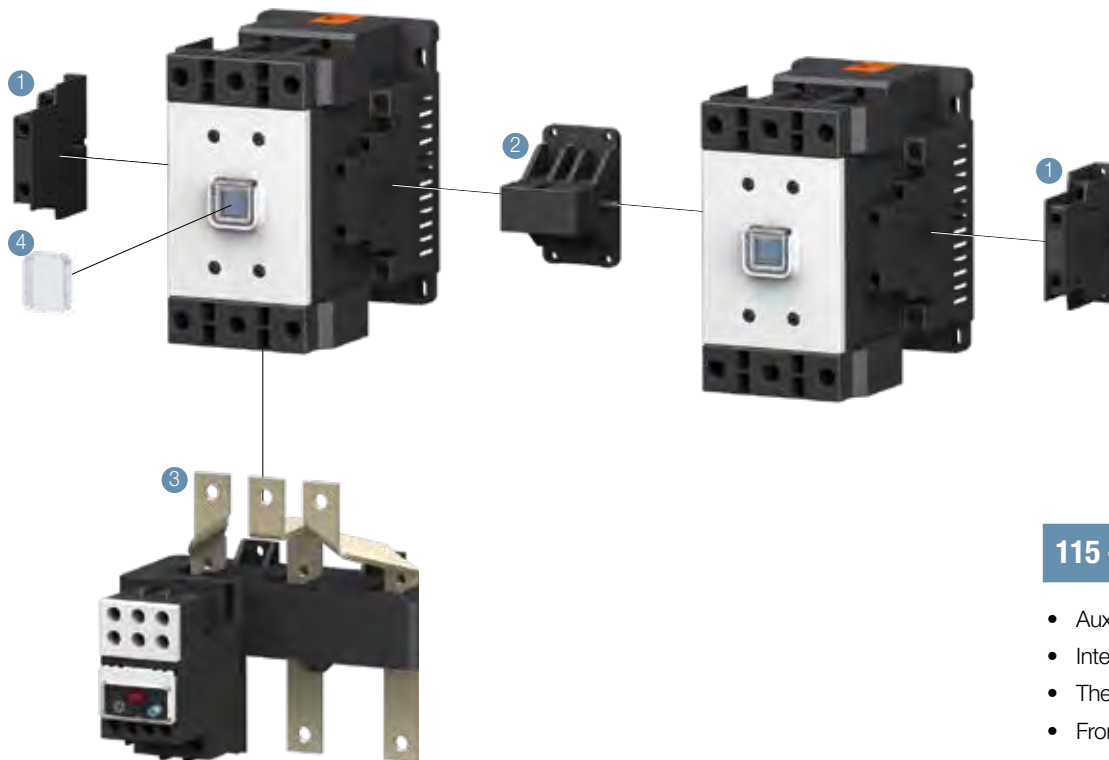

## 115 - 800 AF

- Auxiliary Contact Block HGS SB
- Interlock Unit HGS IU
- Thermal Overload Relay HGST
- Front Safety Cover

## Accessories - HGS Series Contactors



HSN Code: 85389000

Description	Configuraton	Suitable for	Item Code	Per Unit LP (₹)
Aux Contact Block (Side Mounting)	1NO + 1NC	HGS 9-HGS 40 (For all contactors in Frame-1 and Frame-2)	ISSPCU1969	697.00
		HGS50-HGS 100 (For all contactors in Frame-3 and Frame-4)	ISSPCU1970	
		HGS115- HGS 800	ISSPCU1971	825.00
Aux Contact Block (Top Mounting)	2NC	HGS9-HGS100 (For all contactors in Frame-1 to Frame-4)	ISSPCU1961	720.00
	1NO + 1NC		ISSPCU1962	
	2NO		ISSPCU1963	
	4NC		ISSPCU1964	
	1NO + 3NC		ISSPCU1965	
	2NO + 2NC		ISSPCU1966	
	3NO + 1NC		ISSPCU1967	
4NO	ISSPCU1968			
Mechanical Interlock Unit		HGS 9-HGS 40 # (For all contactos in Frame-1 and Frame-2)	ISSPCU1972	944.00
		HGS50-HGS 100 (For all contactors in Frame-3 and Frame-4)	ISSPCU1973	2218.00
		HGS115- HGS 265	ISSPCU1974	3923.00
		HGS 300- HGS 800	ISSPCU1975	4448.00
Mechanical Latching Block (Top Mounting)	220 V AC	HGS 9-HGS 100 (For all contactors in Frame-1 to Frame-4)	ISSPCU1976	2224.00
Electronic Timer (Top Mounting)		HGS 9-HGS 100 (For all contactors in Frame-1 to Frame-4)	ISSPCU1977	3006.00
Surge Absorber* (Surge Suppressor Type RC)	220 V - 240 V AC	HGS 9-HGS 100 (For all contactors in Frame-1 to Frame-4)	ISSPCU1984	1896.00

# - One contactor of Frame-1 and another contactor of Frame-2 can also be interlocked using this Mechanical Interlock Unit.  
\*Contact to nearest branch - ● For other voltages in RC type surge suppressors ● For other type of surge suppressors

## Spare Coils - HGS Contactors (Refer Frame Sizes in Respective Contactor Table)

HSN Code: 85389000

Suitable for	Coil Type	Voltage	Item Code	Per Unit LP (₹)
For all Frame-1 Contactors (HGS 9 to HGS 22)	AC	24 V	ISSPCU1985	623.00
		110 V	ISSPCU1987	
		240 V	ISSPCU1989	
		415 V	ISSPCU2050	
		150 V-300 V	ISSPCU2215	
		260 V-440 V	ISSPCU2134	
For all Frame-2 Contactors (HGS 25-HGS 40)	AC	24 V	ISSPCU1993	623.00
		110 V	ISSPCU1995	
		240 V	ISSPCU1997	
		415 V	ISSPCU2053	
		150 V-300 V	ISSPCU2216	
		260 V-440 V	ISSPCU2135	
For all Frame-3 Contactors (HGS 50-HGS 65)	AC	24 V	ISSPCU2001	2030.00
		110 V	ISSPCU2003	
		240 V	ISSPCU2005	
		415 V	ISSPCU2007	
		260 V-440 V	ISSPCU2136	
For all Frame-4 Contactors (HGS 75-HGS 100)	AC	24 V	ISSPCU2009	2337.00
		110 V	ISSPCU2011	
		240 V	ISSPCU2013	
		415 V	ISSPCU2015	
		260 V-440 V	ISSPCU2137	
For Frame-5 Contactors (HGS 115-HGS 150)	AC/DC Universal Coil	100 Vac-240 Vac 110 Vdc -220 Vdc	ISSPCU1979	6325.00
	AC	380 Vac-450 Vac	ISSPCU2479	
For Frame-6 Contactors (HGS 185-HGS 265)	AC/DC Universal Coil	100 Vac-240 Vac 110 Vdc -220 Vdc	ISSPCU1980	8957.00
	AC	380 Vac-450 Vac	ISSPCU2312	
For Frame-7 Contactors (HGS 300-HGS 500)	AC/DC Universal Coil	100 Vac-240 Vac 110 Vdc -220 Vdc	ISSPCU1981	11647.00
	AC	380 Vac-450 Vac	ISSPCU2103	
For Frame-8 Contactors (HGS 630-HGS 800)	AC/DC Universal	110 Vac-127 Vac	ISSPCU2480	23880.00
		100 Vdc -110 Vdc 200 Vac-240 Vac	ISSPCU1982	
		200 Vdc -220 Vdc	ISSPCU2104	

Effective from 11th March, 2024

List Price (LP) are in Indian ₹ & as per Standard Terms & Conditions **HAVELLS 13**

# Thermal Over Load Relay (Auto/ Manual Reset) - HGST Series



## Features:

- Range : 0.12 A – 800 A available in 8 Frames, Trip class - 10 A
- Conforms to IS/IEC 60947-4-1
- Protection against overload & phase loss protection
- Auto / manual reset facility
- Contactor mounting / Individual mounting with adaptor
- Transparent protection cover for dust application

HSN Code: 85364900

Relay Fr. size	Relay Range (A)	Suitable for Contactor Frame size	Type	Item Code	Per Unit LP (₹)
1	0.12 A - 0.18 A	HGS 9 HGS 12 HGS 18 HGS 22	HGST18	IHHR13CA	1901.00
	0.18 A - 0.26 A			IHHR13CB	
	0.25 A - 0.35 A			IHHR13CC	
	0.34 A - 0.5 A			IHHR13CD	
	0.5 A - 0.7 A			IHHR13CE	
	0.6 A - 0.9 A			IHHR13CF	
	0.8 A - 1.2 A			IHHR13CG	
	1.1 A - 1.6 A			IHHR13CH	
	1.5 A - 2.1 A			IHHR13CJ	
	2 A - 3 A			IHHR13CZ	
	2.8 A - 4.2 A			IHHR13CK	
	3 A - 5 A			IHHR13CL	
	4 A - 6 A			IHHR13CM	
	5.6 A - 8 A			IHHR13CN	
	6 A - 9 A			IHHR13CP	
2	7 A - 10.0 A	HGS 25 HGS 32 HGS 40	HGST 40	IHHR23CQ	2124.00
	8 A - 12.0 A			IHHR23CR	
	12 A - 18 A			IHHR23CT	
	15 A - 22 A			IHHR23CU	2376.00
	17 A - 25 A			IHHR23CV	3001.00
	22 A - 32 A			IHHR23CW	3115.00
	28 A - 40 A			IHHR23CX	
3	7 A - 10.0 A	HGS 50 HGS 65	HGST 65	IHHR33CQ	3722.00
	8 A - 12.0 A			IHHR33CR	
	12 A - 18 A			IHHR33CT	
	15 A - 22 A			IHHR33CU	
	17 A - 25 A			IHHR33CV	
	22 A - 32 A			IHHR33CW	
	28 A - 40 A			IHHR33CX	4408.00
	34 A - 50 A			IHHR33CY	
	45 A - 65 A			IHHR33C1	5248.00

Relay Fr. size	Relay Range (A)	Suitable for Contactor Frame size	Type	Item Code	Per Unit LP (₹)
4	17 A - 25 A	HGS 75 HGS 85 HGS 100	HGST 100	IHHR43CV	4320.00
	22 A - 32 A			IHHR43CW	
	28 A - 40 A			IHHR43CX	
	34 A - 50 A			IHHR43CY	5464.00
	45 A - 65 A			IHHR43C1	
	52 A - 75 A			IHHR43C2	
	59 A - 85 A			IHHR43C3	6092.00
	70 A - 100 A			IHHR43C4	
	5			48 A - 80 A	HGS 115 HGS 130 HGS 150
69 A - 115 A		IHHR53C6			
78 A - 130 A		IHHR53C7			
90 A - 150 A		IHHR53C8			
6	48 A - 80 A	HGS 185 HGS 225 HGS 265	HGST 265	IHHR63C5	9800.00
	69 A - 115 A			IHHR63C6	
	78 A - 130 A			IHHR63C7	
	90 A - 150 A			IHHR63C8	10811.00
	111 A - 185 A			IHHR63C9	
	135 A - 225 A			IHHR63C11	
7	159 A - 265 A	HGS 300 HGS 400 HGS 500	HGST 500	IHHR63C12	11896.00
	190 A - 300 A			IHHR63C10	
	240 A - 400 A			IHHR73C8	11906.00
	300 A - 500 A			IHHR73C9	
	378 A - 630 A			IHHR73C11	
	480 A - 800 A			IHHR73C12	13044.00
	378 A - 630 A			IHHR73C13	
	480 A - 800 A			IHHR73C14	
8	378 A - 630 A	HGS 630 HGS 800	HGST 800	IHHR83C16	32609.00
	480 A - 800 A			IHHR83C17	

## Relay Adapter HSN Code: 85389000

Suitable for	Item code	Per Unit LP (₹)
For all Frame-1 Contactors (HGS 9 to HGS 22)	ISSPCU2681	350.00
For all Frame-2 Contactors (HGS 25-HGS 40)	ISSPCU2682	470.00

# Magnetic Contactor

## Capacitor Duty Contactor

### Features:

- Range : 3 kVAr to 66 kVAr
- De-latching Type design of Resistor Switching Block
- Low VA Burden Wide operating band coils with Class H Insulation
- Common accessories with HGS Range
- High Operating Frequency - 240 Operations per hour
- Handle high inrush current capability
- Utilization category AC-6b
- Finger proof IP20 terminals



HSN Code: 85369090

Frame Size	kVAr Rating AC-6b	Inst. Aux. Contact		Item Code	Per Unit LP (₹)
	415 V / 440 V	NO	NC		
1	3 kVAr	1	0	IHPHE003110*	2522.00
	3 kVAr	0	1	IHPHE003101*	2522.00
	5 kVAr	1	0	IHPHE005110*	2646.00
	5 kVAr	0	1	IHPHE005101*	2646.00
	10 kVAr	1	0	IHPHE010110*	3204.00
	10 kVAr	0	1	IHPHE010101*	3204.00
	12.5 kVAr	1	0	IHPHE12X110*	3619.00
	12.5 kVAr	0	1	IHPHE12X101*	3619.00
	15 kVAr	1	0	IHPHE015110*	4431.00
	15 kVAr	0	1	IHPHE015101*	4431.00
2	20 kVAr	1	0	IHPHE020210*	4871.00
	20 kVAr	0	1	IHPHE020201*	4871.00
	25 kVAr	1	0	IHPHE025210*	5556.00
	25 kVAr	0	1	IHPHE025201*	5556.00
	33.3 kVAr	1	0	IHPHE33X210*	8052.00
	33.3 kVAr	0	1	IHPHE33X201*	8052.00
3	33.3 kVAr	1	1	IHPHE33X311*	9711.00
	40 kVAr	2	2	IHPHE040322*	14926.00
4	50 kVAr	2	2	IHPHE050422*	15529.00
	66 kVAr	2	2	IHPHE066422*	18223.00

\*To complete the Cat no. suffix the coil voltage from the coil voltage table

33.3 kVAr contactor in Frame-3 can be used where higher terminal capacity is required.

### Coil Voltage Selection Table (3)

3 kVAr - 66 kVAr AC Coil

Product	24 Vac	110 Vac	240 Vac	150 Vac-300 Vac	260 Vac-440 Vac	415 Vac
HGS Capacitor Duty Contactor (3 kVAr - 66 kVAr)	B	H	N	S*	W	T

\*upto 33.3 kVAr for AC - 6B

#For Capacitor & Reactor  
kindly refer to page 96, 98, 99



Scan for  
HGS  
Catalogue



Scan for  
Type-2  
Co-ordination  
Charts

# HGSCD

- Compact size – Four (4) frames rating from 9 A to 105 A.
- IP20 guarded terminals prevent accidental contact with live parts.
- IEC & CE markig & Compliance to IS/IEC 60947-4-1
- 4 Terminal Coils on all DC Coil Contactors for control application flexibility.
- 50 A to 105 A DC operated devices feature electronic coil control.
- Thermal Overload Relays direct mount onto HGSCD Series 9 A - 25 A Contactors, reducing installation time and Space.
- 35mm DIN rail mounting for all the contactors from 9 A to 105 A.
- Combination head terminal screws on 50 A through 105 A contactors

## DC Contactor (HGSCD)



## Thermal Overload Relay (HGSDR)



1 AF

2 AF

HGSCD  
Rated Current  
Rated Operational  
Voltage

9 A, 12 A, 18 A, 25 A  
690 V

32 A, 40 A  
690 V

HGSDR  
Setting Current

0.28 A - 32 A

25 A - 40 A

# HGSDR / MR



- 5 Frame sizes current rating up to 112 A suitable for DC / Mini Contactor.
- Overload Relays include integral connection to auxiliary and coil terminations for ease of wiring during installation, when installed on HGSCM Series.
- These Overload Relays share the same great features and benefits of the larger frame sizes.
- Trip Class 10 for reliable and accurate protection against overload conditions.
- Single phase sensitivity to protect motors against damaging phase loss conditions.
- Direct mounting to all contactors.
- IP20 guarded terminals prevent accidental contact with live parts.
- Stop button for convenient and economical control circuit wiring.



50 A / 65 A, 80 A  
690 V / 1000 V

32 A - 70 A



95 A, 105 A  
1000 V

63 A - 112 A

# HGSCM

- Compact size – one frame size for devices rated up to 16 A.
- AC and DC operating coils for control circuit application flexibility – device is the same physical size with an AC or DC coil.
- Front Mounted auxiliary contacts and surge suppressors install directly on top of the single front mounted mechanical interlock.
- High visibility label for ease of troubleshooting and maintenance.
- Mini contactors compatible with directly mounted Thermal Overload Relays with current ratings from 0.28 A to 17 A.
- Over load relays are Class 10 with selectable manual or automatic reset, and provide phase loss sensitivity.
- IP20 guarded terminals.
- 35mm DIN rail mounting for fast and easy installation

## Mini Contactor (HGSCM)



## Thermal Overload Relay (HGSMR)



1 AF

HGSCM  
Rated Current  
Rated Operational  
Voltage

7 A, 9 A, 12 A, 16 A,  
690 V

HGSMR  
Setting Current

0.28 A - 17 A

### 3 Pole DC Contactors - HGSCD



- Compact size – Four (4) frames rating from 9 A to 105 A.
- Finger proof IP 20 terminals
- IEC & CE marking & Compliance to IS/IEC 60947-4-1
- 4 Terminal Coils on all DC Coil Contactors for control application flexibility.
- 50 A to 105 A DC operated devices feature electronic coil control.

HSN Code: 85369090

Frame Size	AC-3 Duty Rating	AC-1 Duty Rating	Power Poles	In - built Aux contacts		Type	Code	Description	Per Unit LP (₹)
	le A	lth A		NC	NO				
1	9	25	3	1	0	HGSCD 9	IHPDB009101*	Frame-1 9A 3P1NC DC Contactor	2426.00
	9	25	3	0	1	HGSCD 9	IHPDB009110*	Frame-1 9A 3P1NO DC Contactor	2426.00
	12	25	3	1	0	HGSCD 12	IHPDB012101*	Frame-1 12A 3P1NC DC Contactor	2693.00
	12	25	3	0	1	HGSCD 12	IHPDB012110*	Frame-1 12A 3P1NO DC Contactor	2693.00
	18	45	3	1	0	HGSCD 18	IHPDB018101*	Frame-1 18A 3P1NC DC Contactor	3069.00
	18	45	3	0	1	HGSCD 18	IHPDB018110*	Frame-1 18A 3P1NO DC Contactor	3069.00
	25	45	3	1	0	HGSCD 25	IHPDB025101*	Frame-1 25A 3P1NC DC Contactor	4515.00
	25	45	3	0	1	HGSCD 25	IHPDB025110*	Frame-1 25A 3P1NO DC Contactor	4515.00
2	32	60	3	0	0	HGSCD 32	IHPDB032200*	Frame-2 32A 3P DC Contactor	8742.00
	40	60	3	0	0	HGSCD 40	IHPDB040200*	Frame-2 40A 3P DC Contactor	12207.00
3	50	90	3	0	0	HGSCD 50	IHPDB050300*	Frame-3 50A 3P DC Contactor	15425.00
	65	110	3	0	0	HGSCD 65	IHPDB065300*	Frame-3 65A 3P DC Contactor	16514.00
	80	110	3	0	0	HGSCD 80	IHPDB080300*	Frame-3 80A 3P DC Contactor	20642.00
4	95	140	3	0	0	HGSCD 95	IHPDB095400*	Frame-4 95A 3P DC Contactor	26394.00
	105	140	3	0	0	HGSCD 105	IHPDB105400*	Frame-4 105A 3P DC Contactor	31463.00

### DC Coil Voltage Selection Table

DC Coil Codes							
Frame	I	B	E	H	M	L	
1	12 V	24 V	48 V	110 V	220 V	250 V	
2	12 V	24 V	48 V	110 V	220 V	250 V	
3	12 V	24 V	48 V	110 V	220 V	250 V	
4	12 V	24 V	48 V	110 V	220 V	250 V	

### 3 Pole Mini Contactors with AC Coil - HGSCM



- Compact size – one frame size for devices rated up to 16 A.
- Same size for AC or DC coil contactor
- Directly mounted Thermal Overload Relays
- Over load relays Class 10 with selectable M/A reset & SPP
- IP20 guarded terminals

HSN Code: 85369090

Frame Size	AC-3 Duty Rating	AC-1 Duty Rating	Power Poles	In - built Aux contacts		Type	Code	Description	Per Unit LP (₹)
	le A	lth A		NC	NO				
1	7	18	3	1	0	HGSCM	IHPNA007101*	F-1 7A 3P1NC Mini AC Cont	1555.00
	7	18	3	0	1	HGSCM	IHPNA007110*	F-1 7A 3P1NO Mini AC Cont	1555.00
	9	20	3	1	0	HGSCM	IHPNA009101*	F-1 9A 3P1NC Mini AC Cont	1683.00
	9	20	3	0	1	HGSCM	IHPNA009110*	F-1 9A 3P1NO Mini AC Cont	1683.00
	12	22	3	1	0	HGSCM	IHPNA012101*	F-1 12A 3P1NC Mini AC Cont	1792.00
	12	22	3	0	1	HGSCM	IHPNA012110*	F-1 12A 3P1NO Mini AC Cont	1792.00
	16	22	3	1	0	HGSCM	IHPNA016101*	F-1 16A 3P1NC Mini AC Cont	2119.00
	16	22	3	0	1	HGSCM	IHPNA016110*	F-1 16A 3P1NO Mini AC Cont	2119.00

### AC Coil Voltage Selection Table

AC Coil Codes									
Frame	B	E	H	M	N	R	T	U	
1	24 V	48 V	110 V	220 V	240 V	380 V	415 V	440 V	

Effective from 11th March, 2024

List Price (LP) are in Indian ₹ & as per Standard Terms & Conditions **HAVELLS 19**

### 3 Pole Mini Contactors with DC Coil - HGSCM



- Compact size – one frame size for devices rated up to 16 A.
- Same size for AC or DC coil contactor
- Directly mounted Thermal Overload Relays
- Over load relays Class 10 with selectable M/A reset & SPP
- IP20 guarded terminals

HSN Code: 85369090

Frame Size	AC-3 Duty Rating	AC-1 Duty Rating	Power Poles	In - built Aux contacts		Type	Code	Description	Per Unit LP (₹)
	Ie A	Ith A		NC	NO				
1	7	18	3	1	0	HGSCM	IHPNB007101*	F-1 7A 3P1NC Mini DC Cont	2268.00
1	7	18	3	0	1	HGSCM	IHPNB007110*	F-1 7A 3P1NO Mini DC Cont	2268.00
1	9	20	3	1	0	HGSCM	IHPNB009101*	F-1 9A 3P1NC Mini DC Cont	2367.00
1	9	20	3	0	1	HGSCM	IHPNB009110*	F-1 9A 3P1NO Mini DC Cont	2367.00
1	12	22	3	1	0	HGSCM	IHPNB012101*	F-1 12A 3P1NC Mini DC Cont	2594.00
1	12	22	3	0	1	HGSCM	IHPNB012110*	F-1 12A 3P1NO Mini DC Cont	2594.00
1	16	22	3	1	0	HGSCM	IHPNB016101*	F-1 16A 3P1NC Mini DC Cont	2862.00
1	16	22	3	0	1	HGSCM	IHPNB016110*	F-1 16A 3P1NO Mini DC Cont	2862.00

#### DC Coil Voltage Selection Table

DC Coil Codes						
Frame	I	B	E	H	M	L
1	12 V	24 V	48 V	110 V	220 V	250 V

### 3 Pole Mini Control Relay with AC Coil - HGSCR

- Compact size – one frame size for devices rated up to 16 A.
- Same size with an AC or DC coil contactor.

HSN Code: 85364900

Frame Size	AC-1 Duty Rating	In - built Aux contacts		Type	Code	Description	Per Unit LP (₹)
	Ith A	NC	NO				
1	16	2	2	HGSCR	IHMCR22*	Mini Cont. 2NO2NC Control Relay AC	1802.00
1	16	3	1	HGSCR	IHMCR31*	Mini Cont. 3NO1NC Control Relay AC	1802.00
1	16	4	0	HGSCR	IHMCR40*	Mini Cont. 4NO Control Relay AC	1802.00
1	16	0	4	HGSCR	IHMCR04*	Mini Cont. 4NC Control Relay AC	1802.00
1	16	1	3	HGSCR	IHMCR13*	Mini Cont. 1NO3NC Control Relay AC	1802.00

#### AC Coil Voltage Selection Table

AC Coil Codes							
Frame	B	E	H	M	N	T	V
1	24 V	48 V	110 V	220 V	240 V	415 V	480 V

### 3 Pole Mini Control Relay with DC Coil - HGSCR

- Compact size – one frame size for devices rated up to 16 A.
- Same size with an AC or DC coil contactor.

HSN Code: 85364900

Frame Size	AC-1 Duty Rating	In - built Aux contacts		Type	Code	Description	Per Unit LP (₹)
	Ith A	NC	NO				
1	16	2	2	HGSCR	IHMDR22*	Mini Cont. 2NO2NC Control Relay DC	2406.00
1	16	3	1	HGSCR	IHMDR31*	Mini Cont. 3NO1NC Control Relay DC	2406.00
1	16	4	0	HGSCR	IHMDR40*	Mini Cont. 4NO Control Relay DC	2406.00
1	16	0	4	HGSCR	IHMDR04*	Mini Cont. 4NC Control Relay DC	2406.00
1	16	1	3	HGSCR	IHMDR13*	Mini Cont. 1NO3NC Control Relay DC	2406.00

#### DC Coil Voltage Selection Table

DC Coil Codes					
Frame	I	B	H	J	P
1	12 V	24 V	110 V	120 V	250 V

### 3 Pole DC, Mini Contactor Accessories

#### Accessories - HGSCD Series Contactors

HSN Code: 85389000

Description	Configuraton	Suitable for	Item Code	Per Unit LP (₹)
Aux Contact Block (Side Mounting)	1NO	HGSCD 9-HGSCD 105	ISSPEN0005	434.00
	1NC		ISSPEN0006	434.00
	1NO + 1NC		ISSPEN0007	765.00
	2NO		ISSPEN0008	765.00
Aux Contact Block (Front Mounting)	1NO		ISSPEN0001	255.00
	1NC		ISSPEN0002	255.00
	1NO (EM)		ISSPEN0003	561.00
	1NC (DB)		ISSPEN0004	561.00
Mechanical Interlock Unit			ISSPEN0077	776.00
Mechanical + Electrical Interlock Unit		ISSPEN0009	1530.00	
Surge Suppressor Type RC	24 V - 48 V AC	HGSCD 40	ISSPEN0010	663.00
	50 V - 127 V AC		ISSPEN0011	663.00
	130 V - 250 V AC		ISSPEN0012	663.00
	24 V - 48 V AC	HGSCD 105	ISSPEN0013	663.00
	50 V - 127 V AC		ISSPEN0014	663.00
	130 V - 250 V AC		ISSPEN0015	663.00

#### Spare Coils - HGSCD Contactors (Refer Frame Sizes in Respective Contactor Table)

HSN Code: 85389000

Suitable for	Coil Type	Voltage	Item Code	Per Unit LP (₹)
For all Frame-1 Contactors (HGSCD 9 to HGSCD 25)	DC	12 V	ISSPEN0016	1785.00
		24 V	ISSPEN0078	1785.00
		48 V	ISSPEN0017	1785.00
		110 V	ISSPEN0018	1785.00
		220 V	ISSPEN0019	1785.00
For all Frame-2 Contactors (HGSCD 32-HGSCD 40)		12 V	ISSPEN0020	1887.00
		24 V	ISSPEN0021	1887.00
		48 V	ISSPEN0022	1887.00
		110 V	ISSPEN0023	1887.00
For Frame -3 Contactors HGSCD 50		24-28 V	ISSPEN0024	4845.00
		48 V	ISSPEN0025	4845.00
		110 V	ISSPEN0026	4845.00
For Frame -3 Contactors HGSCD 65		24 V	ISSPEN0027	4845.00
		48 V	ISSPEN0028	4845.00
		110 V	ISSPEN0029	4845.00
For Frame -4 Contactors HGSCD 80	24 V	ISSPEN0030	8293.00	
	48 V	ISSPEN0031	8293.00	
	110 V	ISSPEN0032	8293.00	
For Frame -4 Contactors HGSCD 105	24 V	ISSPEN0033	8293.00	
	48 V	ISSPEN0034	8293.00	
	110 V	ISSPEN0035	8293.00	

### 3 Pole DC, Mini Contactor Accessories

Accessories - HGSCM Series Contactors & HGSCR Control Relay

HSN Code: 85389000

Description	Configurator	Suitable for	Item Code	Per Unit LP (₹)
Aux Contact Block (Front Mounting)	2NO	HGSCM	ISSPEN0037	480.00
	1NO + 1NC		ISSPEN0038	480.00
	2NC		ISSPEN0039	480.00
	4NO		ISSPEN0040	781.00
	2NO + 2NC		ISSPEN0041	781.00
	4NC		ISSPEN0042	781.00
	3NO + 1NC		ISSPEN0043	781.00
	1NO + 3NC		ISSPEN0044	781.00
Surge Suppressor Type RC	12 V - 24 V AC		ISSPEN0054	765.00
	24 V - 48 V AC		ISSPEN0055	765.00
	50 V - 127 V AC		ISSPEN0056	765.00
	130 V - 250 V AC		ISSPEN0057	765.00
	275 V - 380 V AC		ISSPEN0058	765.00
	400 V - 510 V AC		ISSPEN0059	765.00
Surge Suppressor Type Varistor	12 V - 48 V AC / 12 V - 60 V DC	ISSPEN0060	765.00	
	275 V - 380 V AC	ISSPEN0061	765.00	
	400 V - 510 V AC	ISSPEN0062	765.00	
	50 V - 127 V AC / 60 V - 180 V DC	ISSPEN0063	765.00	
	130 V - 250 V AC / 180 V - 300 V DC	ISSPEN0064	765.00	
	277 V - 380 V AC / 380 V - 510 V DC	ISSPEN0065	765.00	
Mechanical Interlock Unit			ISSPEN0053	725.00
Aux Contact Block (Front Mounting)	2NO	HGSCR	ISSPEN0045	480.00
	1NO + 1NC		ISSPEN0046	480.00
	2NC		ISSPEN0047	480.00
	4NO		ISSPEN0048	781.00
	2NO + 2NC		ISSPEN0049	781.00
	4NC		ISSPEN0050	781.00
	3NO + 1NC		ISSPEN0051	781.00
	1NO + 3NC		ISSPEN0052	781.00

### Spare Coils - HGSCM Series Contactors (Refer Frame Sizes in Respective Contactor Table)

HSN Code: 85389000

Suitable for	Coil Type	Voltage	Item Code	Per Unit LP (₹)
For all HGSCM Contactors	AC	24 V	ISSPEN0066	602.00
		48 V	ISSPEN0067	602.00
		110 V / 120 V	ISSPEN0068	602.00
		230 V	ISSPEN0069	602.00
		400 V	ISSPEN0070	602.00
		12 V	ISSPEN0071	1005.00
	DC	24 V	ISSPEN0072	1005.00
		110 V	ISSPEN0073	1005.00
		125 V	ISSPEN0074	1005.00
		250 V	ISSPEN0075	1005.00

## Thermal Over Load Relay (Auto/ Manual Reset) - HGSCD Series

- 4 Frame sizes current rating
- Trip Class 10 A and Built in SPP
- Direct mounting to all contactors.
- IP20 guarded terminals prevent accidental contact with live parts.



HSN Code: 85364900

Frame Size	Relay Range A	Suitable for Contactor Frame Size	Type	Code	Per Unit LP (₹)
2	0.28 A-0.4 A	HGSCD009 HGSCD012 HGSCD018 HGSCD025 HGSCD032 HGSCD040	HGSDR	IHDR23C18	1961.00
	0.4 A-0.63 A		HGSDR	IHDR23C19	1961.00
	0.56 A-0.8 A		HGSDR	IHDR23C20	1961.00
	0.8 A-1.2 A		HGSDR	IHDR23C21	1961.00
	1.2 A-1.8 A		HGSDR	IHDR23C22	1961.00
	1.8 A-2.8 A		HGSDR	IHDR23C23	1961.00
	2.8 A-4 A		HGSDR	IHDR23C24	1961.00
	4 A-6.3 A		HGSDR	IHDR23C25	1961.00
	5.6 A-8 A		HGSDR	IHDR23C26	1961.00
	7 A-10 A		HGSDR	IHDR23C27	1961.00
	8 A-12.5 A		HGSDR	IHDR23C28	1961.00
	10 A-15 A		HGSDR	IHDR23C29	1961.00
	11 A-17 A		HGSDR	IHDR23C30	2367.00
	15 A-23 A		HGSDR	IHDR23C31	2367.00
22 A-32 A	HGSDR	IHDR23C32	3673.00		
3	25 A-40 A	HGSCD032 HGSCD040	HGSDR	IHDR33C33	3673.00
4	32 A-50 A	HGSCD050 HGSCD065 HGSCD080	HGSDR	IHDR43C34	4733.00
	40 A-57 A		HGSDR	IHDR43C35	5017.00
	50 A-63 A		HGSDR	IHDR43C36	6079.00
	57 A-70 A		HGSDR	IHDR43C37	6079.00
5	63 A-80 A	HGSCD095 HGSCD105	HGSDR	IHDR53C38	6713.00
	78 A-97 A		HGSDR	IHDR53C39	6772.00
	90 A-112 A		HGSDR	IHDR53C40	9217.00

## Thermal Over Load Relay (Auto/ Manual Reset) - HGSCM Series

- 1 Frame sizes current rating
- Trip Class 10 A and Built in SPP
- Direct mounting to all contactors.
- IP20 guarded terminals prevent accidental contact with live parts.



HSN Code: 85364900

Frame Size	Relay Range A	Suitable for Contactor Frame Size	Type	Code	Per Unit LP (₹)
1	0.28 A-0.4 A	HGSCM007 HGSCM009 HGSCM012 HGSCM016	HGSMR	IHMR13C18	2014.00
	0.4 A-0.63 A			IHMR13C19	2014.00
	0.56 A-0.8 A			IHMR13C20	2014.00
	0.8 A-1.2 A			IHMR13C21	2014.00
	1.2 A-1.8 A			IHMR13C22	2014.00
	1.8 A-2.8 A			IHMR13C23	2014.00
	2.8 A-4 A			IHMR13C24	2035.00
	4 A-6.3 A			IHMR13C25	2035.00
	5.6 A-8 A			IHMR13C26	2035.00
	7 A-10 A			IHMR13C27	2035.00
	8 A-12.5 A			IHMR13C28	2056.00
	10 A-15 A			IHMR13C29	2056.00
	11 A-17 A			IHMR13C30	2056.00

# Motor Protection Circuit Breakers

## MPCB Push button version

- HGSM : Thermal Magnetic, 0.1 A - 32 A
- Short Circuit + Overload Protection
- Icu= 100 kA upto 10 A, Icu=15 kA for 9 A - 25 A & Icu= 10 kA for 24 A - 32 A

## Rotary MPCB Fr 1

- HGSTMR : Thermal Magnetic
- Short Circuit Protection + Overload Protection
- Fr 1 - Icu= 100 kA upto 6.3 A & Icu= 50 kA from 6.3 A - 32 A
- Fr 2 - Icu= 50 kA from 11 A - 63 A

## Rotary MPCB Fr 2

- HGSMR : Magnetic
- Short Circuit Protection
- Fr 1 - Icu= 100 kA from 0.16 A - 6.3 A & Icu= 50 kA from 10 A - 32 A
- Fr 2 - Icu= 50 kA from 16 A - 63 A

## Range & Switching Capabilities

Type	Operating Method	Version	Protections Offered	Frame & Size	Ratings and Braking Capacity		
HGSM	Push-Button	Thermal Magnetic	OL, SC, Single Phasing	Fr-1 45 mm	0.1 A - 10 A 100 kA	9 A - 25 A 15 kA	24 A - 32 A 10 kA
HGSTMR	Rotary	Thermal Magnetic	OL, SC, Single Phasing	Fr-1 45 mm	0.1 A - 6.3 A 100 kA	6.3 A - 32 A 50 kA	
				Fr-2 55 mm	11 A - 63 A 50 kA		
HGSMR	Rotary	Magnetic	SC	Fr-1 45 mm	0.16 A - 6.3 A 100 kA	10 A - 32 A 50 kA	
				Fr-2 55 mm	16 A - 63 A 50 kA		



- Short circuit protection
- Over current protection
- Overload protection
- Phase loss protection
- Wide range of current adjustment dial

- Compact
- High breaking capacity
- Short circuit protective coordination
- Reduction in wiring work
- High switching durability
- Padlocking feature available
- Stand alone motor protection
- Common accessories

Circuit Breaker

Circuit Breaker

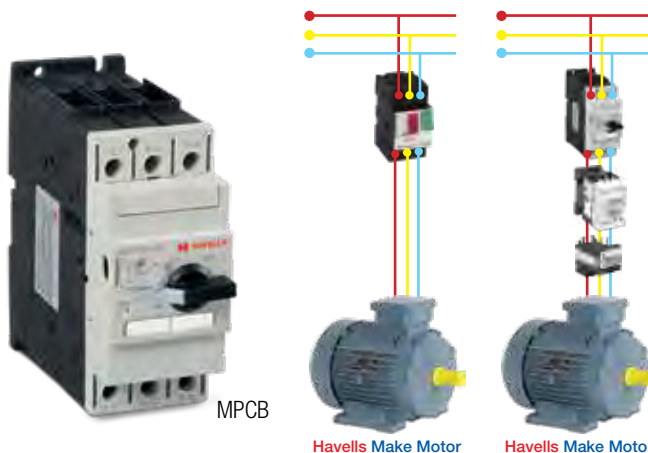

## Accessories Overview : Push Button MPCB

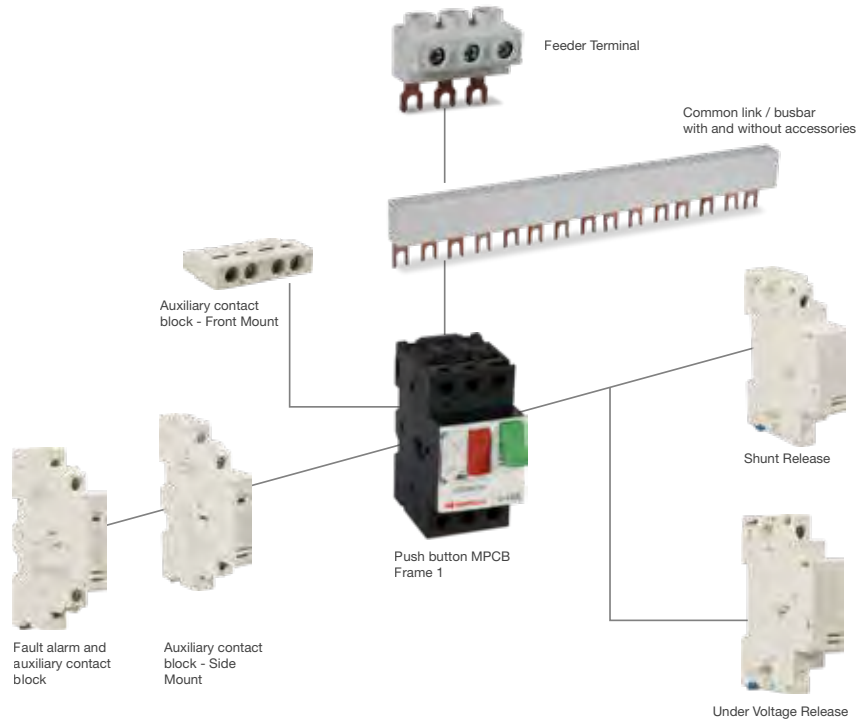

## Accessories Overview : Rotary MPCB

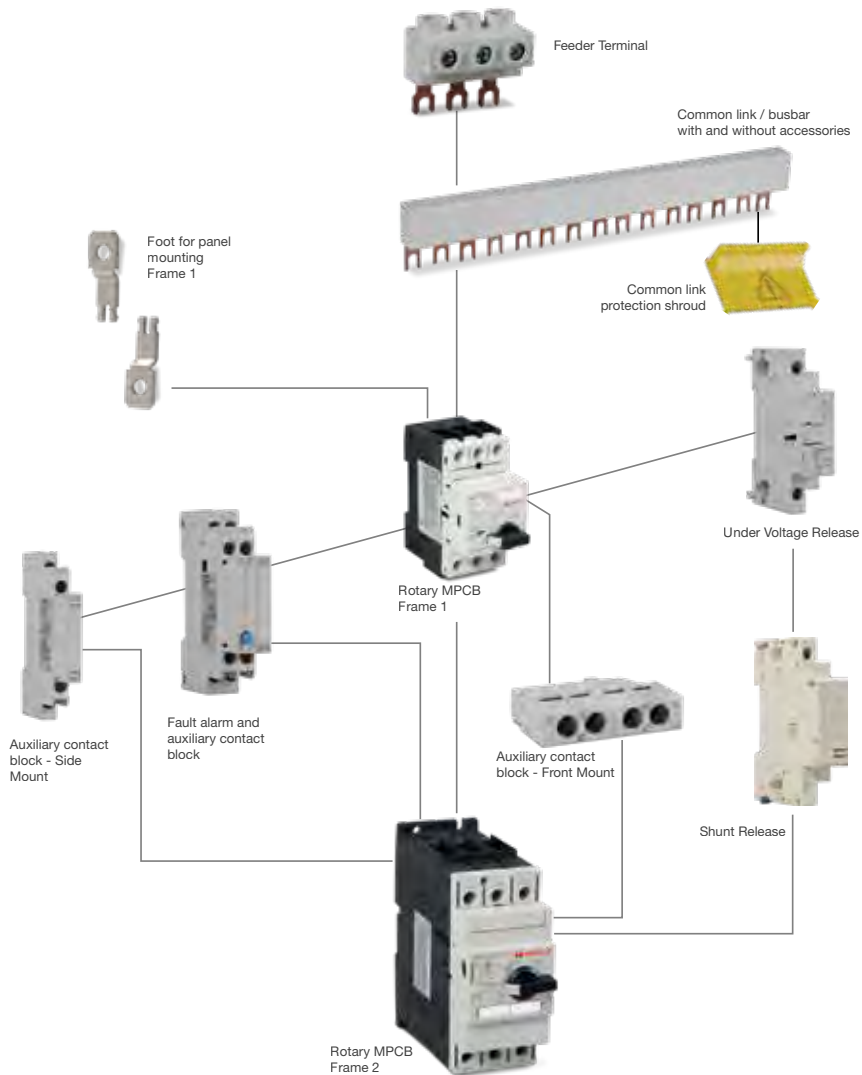

# MPCB - Motor Protection Circuit Breaker - HGSM Series

## MPCB specially coordinated for IE2, IE3 & IE4 Motors

### Push Button Version\*

#### Features:

- 1 Frame size - 45 mm width
- High Magnetic Setting - Makes it suitable for IE2, IE3 and IE4 Motors
- Tripping class: 10 A
- Mechanical Life: 100000 cycles
- Electrical Life: 100000 cycles
- Compliance to IEC 60947-2, IEC 60947-4-1
- Finger proof IP20 Terminals
- Lockable in OFF Position



## HGSM - Thermal Magnetic Series

HSN Code: 85362090

Frame	Model	Breaking Capacity kA 415 V, 50 Hz	Current Rating	Item Code	Per Unit LP (₹)	
1	HGSM	100	0.1 A - 0.16 A	IHHMPBA2A0	2847.00	
			0.16 A - 0.25 A	IHHMPBB2B0		
			0.25 A - 0.4 A	IHHMPBC2D0		
			0.4 A - 0.63 A	IHHMPBD2E0		
			0.63 A - 1 A	IHHMPBE2F0		
			1 A - 1.6 A	IHHMPBF2G0		
			1.6 A - 2.5 A	IHHMPBG2R0		
			2.5 A - 4 A	IHHMPBH2I0		
		15	4 A - 6.3 A	IHHMPBJ2J0	3370.00	
			6.3 A - 10 A	IHHMPBK2K0	3603.00	
			9 A - 14 A	IHHMPBL2L0	4056.00	
			13 A - 18 A	IHHMPBN2M0	4620.00	
		10		17 A - 23 A	IHHMPBQ2T0	4860.00
				20 A - 25 A	IHHMPBS2N0	4860.00
		24 A - 32 A	IHHMPBT2P0	8480.00		

## Motor Protection Circuit Breaker - HGSM Series Accessories

HSN Code: 85389000

Description	Configuraton	Suitable for	Item Code	Per Unit LP (₹)
Aux Contact Block (Side Mounting)	2NO	HGSM MPCB	ISSPCU2414	763.00
	1NO + 1NC		ISSPCU2415	
Aux Contact Block (Top Mounting)	2NO		ISSPCU2412	763.00
	1NO + 1NC		ISSPCU2413	
UV Release	110V AC		ISSPCU2406	2120.00
	240V AC		ISSPCU2407	
	415V AC		ISSPCU2408	
Shunt Release	110V AC		ISSPCU2409	2120.00
	240V AC		ISSPCU2410	
	415V AC		ISSPCU2411	
Fault Alarm	1NC + 1NO		ISSPCU2416	1052.00
	1NC + 1NC		ISSPCU2417	
	1NO + 1NO		ISSPCU2418	
Water proof Box IP55			ISSPCU2419	1532.00
Emergency Water proof Box IP55		ISSPCU2420	1589.00	



# MPCB Motor Protection Circuit Breaker - HGSTMR / HGSMR Series

## MPCB specially coordinated for IE2, IE3 & IE4 Motors

### Features:

- Rotary Version - 2 Frame Sizes, 45 mm and 55 mm width
- Thermal magnetic version - Range from 0.1 -63 A, Trip class 10
- Magnetic Only version - Range from 0.16 A - 63 A
- Rated Operational Voltage  $U_i$  : 690 V
- High Magnetic Setting - Makes it suitable for IE2, IE3 and IE4 Motors
- Compliance to IEC 60947-2 and IEC 60947-4-1
- Finger proof IP20 Terminals
- Lockable in OFF Position
- Suitable for DIN channel and Base Mounting both
- CE Marking



### HGSTMR - Thermal Magnetic Series

HSN Code: 85362090

Fr.	Model	Breaking Capacity kA 415 V, 50 Hz	Current Rating	Item Code	Per Unit LP (₹)		
1	HGSTMR - A1	100	0.1 - 0.16 A	IHHMROA1AT	3745.00		
		100	0.16 - 0.25 A	IHHMROB1BT	3745.00		
		100	0.25 - 0.4 A	IHHMROC1DT	3745.00		
		100	0.4 - 0.63 A	IHHMROD1ET	3745.00		
		100	0.63 - 1 A	IHHMROE1FT	3745.00		
		100	1 - 1.6 A	IHHMROF1GT	4280.00		
		100	1.6 - 2.5 A	IHHMROG1RT	4280.00		
		100	2.5 - 4 A	IHHMROH1IT	4280.00		
		100	4 - 6.3 A	IHHMROJ1JT	4280.00		
		50	6.3 - 10 A	IHHMROK1KT	4815.00		
		50	10 - 16 A	IHHMROM1MT	4815.00		
		50	16 - 20 A	IHHMROP1TT	5885.00		
		50	20 - 25 A	IHHMROS1NT	5885.00		
		50	25 - 32 A	IHHMROT1PT	10700.00		
		2	HGSTMR - A2	50	11 - 16 A	IHHMROM3MT	12840.00
				50	14 - 20 A	IHHMROP3TT	12840.00
50	18 - 25 A			IHHMROS3NT	12840.00		
50	22 - 32 A			IHHMROT3PT	17120.00		
50	28 - 40 A			IHHMROU3QT	17120.00		
50	36 - 45 A			IHHMROV3ST	17120.00		
50	40 - 50 A			IHHMROW3ST	17120.00		
50	52 - 63 A			IHHMROX3XT	17120.00		

### HGSMR - Only Magnetic Series

HSN Code: 85362090

Fr.	Model	Breaking Capacity kA 415 V, 50 Hz	Current Rating	Item Code	Per Unit LP (₹)		
1	HGSMR - A1	100	0.16 A	IHHMROA1AM	3371.00		
		100	0.25 A	IHHMROB1BM	3371.00		
		100	0.4 A	IHHMROC1DM	3371.00		
		100	0.63 A	IHHMROD1EM	3371.00		
		100	1.0 A	IHHMROE1FM	3371.00		
		100	0.6 A	IHHMROF1GM	3852.00		
		100	0.5 A	IHHMROG1RM	3852.00		
		100	4.0 A	IHHMROH1IM	3852.00		
		100	6.3 A	IHHMROJ1JM	3852.00		
		50	10 A	IHHMROK1KM	4334.00		
		50	6 A	IHHMROM1MM	4334.00		
		50	20 A	IHHMROP1TM	5297.00		
		50	25 A	IHHMROS1NM	5297.00		
		50	32 A	IHHMROT1PM	9630.00		
		2	HGSMR - A2	50	16 A	IHHMROM3MM	11556.00
				50	20 A	IHHMROP3TM	11556.00
50	25 A			IHHMROS3NM	11556.00		
50	32 A			IHHMROT3PM	15408.00		
50	40 A			IHHMROU3QM	15408.00		
50	45 A			IHHMROV3SM	15408.00		
50	50 A			IHHMROW3SM	15408.00		
50	63 A			IHHMROX3XM	15408.00		

# MPCB specially coordinated for IE2, IE3 & IE4 Motors

## Motor Protection Circuit Breaker - HGSTMR / HGSMR Series Accessories

HSN Code: 85389000

Description	Configurator	Suitable for	Item Code	Per Unit LP (₹)
Aux Contact Block (Side Mounting)	2NO	HGSTMR / HGSMR MPCB	ISSPDU0062	1284.00
	2NC		ISSPDU0061	1284.00
	1NO + 1NC		ISSPDU0063	1284.00
Fault Alarm + Aux Contact Block (Side Mounting)	2 NO + 2NC		ISSPDU0073	2675.00
Aux Contact Block (Top Mounting)	1NO + 1NC		ISSPDU0060	1070.00
UV Release	24 V /28 V		ISSPDU0069	2568.00
	180 V AC		ISSPDU0066	2568.00
	208 V AC		ISSPDU0067	2568.00
	240 V AC		ISSPDU0064	2568.00
Shunt Release	100 V - 127 V AC		ISSPDU0071	2568.00
	20 V - 24 V AC	ISSPDU0070	2568.00	
	200 V - 240 V AC	ISSPDU0072	2568.00	
Operating Handle	HGSRHBG-A1 OPERATING HANDLE-ROT	ISSPDU0089	1391.00	
	HGSRHBG-A2 OPERATING HANDLE-ROT	ISSPDU0091	1712.00	
	HGSRHRY-A1 OPERATING HANDLE-ROT	ISSPDU0090	1391.00	
	HGSRHRY-A2 OPERATING HANDLE-ROT	ISSPDU0092	1712.00	
Enclosure	HGSREBG-A1 IP65/L ENCLOSURE-ROT	ISSPDU0076	3959.00	
	HGSREBG-A1 IP65/S ENCLOSURE-ROT	ISSPDU0074	3424.00	
	HGSRERY-A1 IP65/L ENCLOSURE-ROT	ISSPDU0077	3959.00	
	HGSRERY-A1 IP65/S ENCLOSURE-ROT	ISSPDU0075	3424.00	
Feeder Terminal	HGSRFT-A1 3P FEEDER TERMINALS	ISSPDU0079	856.00	
Terminal Barrier	HGSRBT-A1 3P TERMINAL BARRIER	ISSPDU0080	107.00	
Common Link	HGSRCL-A1 452MM COMMON LINK	ISSPDU0081	749.00	
	HGSRCL-A1 453MM COMMON LINK	ISSPDU0082	856.00	
	HGSRCL-A1 454MM COMMON LINK	ISSPDU0083	1017.00	
	HGSRCL-A1 455MM COMMON LINK	ISSPDU0084	1177.00	
	HGSRCL-A1 542MM COMMON LINK	ISSPDU0085	910.00	
	HGSRCL-A1 543MM COMMON LINK	ISSPDU0086	1017.00	
	HGSRCL-A1 544MM COMMON LINK	ISSPDU0087	1177.00	
	HGSRCL-A1 545MM COMMON LINK	ISSPDU0088	1338.00	



# HGS Motor Starter

HGS  
Global Series



# HGS - Trusted Global Range

## Motor Starters

Motor Control Solutions for higher Safety, Reliability & Performance



DOL Starters  
Ratings - 0.55 kW to 37 kW  
(0.75 HP to 50 HP)



Reversing Starters  
Ratings - 1.5 kW to 15 kW  
(2 HP to 20 HP)



ASD Starters  
Ratings - 7.5 kW to 110 kW  
(10 HP to 150 HP)



ASD 3 $\phi$  Submersible Starters  
Ratings - 22 kW to 37 kW  
(30 HP to 50 HP)



ASD 3 $\phi$  Submersible Starters DLX  
(with Short-circuit Protection)  
Ratings - 22 kW to 37 kW  
(30 HP to 50 HP)

## Direct Online Starter - HGS Series

### Features:

- Range : 0.55 kW to 37 kW (0.75 HP to 50 HP)
- Conforms to IS/IEC 60947-4-1
- Provided with Protection Degree IP 54
- Extended wide band coil
- FRLS (Fire retardant low smoke) Internal wiring
- Starter Type - Air Break
- Class H Insulation



HSN Code: 85369010

HP	kW	Contacting Rating	Overload Relay Range (A)	Item Code	Per Unit LP (₹)
0.75 HP	0.55 kW	12	1.5 A - 2.1 A	IHHDLFA*E	3583.00
1 HP	0.75 kW	12	2 A - 3 A	IHHDLGA*E	
2 HP	1.5 kW	12	2.8 A - 4.2 A	IHHDLHA*E	
3 HP	2.2 kW	12	4.0 A - 6.0 A	IHHDLJA*E	
5 HP	3.7 kW	12	6 A - 9 A	IHHDLA*E	
7.5 HP	5.5 kW	18	12 A - 18 A	IHHDLMA*E	
10 HP	7.5 kW	22	12 A - 18 A	IHHDLNA*E	4301.00
15 HP	11 kW	32	17 A - 25 A	IHHDLPB*E	6945.00
20 HP	15 kW	32	22 A - 32 A	IHHDLWB*	11175.00
25 HP	18.5 kW	40	28 A - 40 A	IHHDLXB*	13550.00
30 HP	22 kW	50	34 A - 50 A	IHHDLYC*	17550.00
40 HP	30 kW	65	45 A - 65 A	IHHDL1C*	21675.00
50 HP	37 kW	85	59 A - 85 A	IHHDL3D*	25135.00

### AC Coil

Code*	T	W
AC Voltage	415 V	260 V - 440 V

## Fully Automatic Star-Delta Starter (ASD) - HGS Series

### Features:

- Range : 7.5 kW to 110 kW (10 HP to 150 HP)
- Conforms to IS/IEC 60947-4-1
- Provided with Protection Degree IP 54
- Extended wide band coil
- FRLS (Fire retardant low smoke) Internal wiring
- Starter Type - Air Break
- Class H Insulation



HSN Code: 85369010

HP	k W	Contacting Size	Overload Relay Range (A)	Item Code	Per Unit LP (₹)
10 HP	7.5 kW	18	8.0 A - 12 A	IHHASDRA*	13615.00
12.5 HP	9.3 kW	18	8.0 A - 12 A	IHHASDTA*	13801.00
15 HP	11 kW	22	12 A - 18.0 A	IHHASDTB*	13863.00
20 HP	15 kW	25	15 A - 22 A	IHHASDUB*	15601.00
25 HP	18.5 kW	32	17 A - 25 A	IHHASDVB*	17560.00
30 HP	22 kW	32	22 A - 32 A	IHHASDWB*	19159.00
35 HP	26 kW	32	28 A - 40 A	IHHASDXB*	28439.00
50 HP	37 kW	50	34 A - 50 A	IHHASDYC*	48558.00
60 HP	45 kW	50	45 A - 65 A	IHHASD1C*A	71256.00
75 HP	55 kW	65	45 A - 65 A	IHHASD1C*B	78382.00
90 HP	67.5 kW	85	59 A - 85 A	IHHASD3D*	91740.00
100 HP	75 kW	100	70 A - 100 A	IHHASD4D*	96254.00
125 HP	90 kW	115	78 A - 130 A	IHHASD7E*	132599.00
150 HP	110 kW	150	90 A - 150 A	IHHASD8E*	134506.00

### AC Coil

Code*	T	W
AC Voltage	415 V	260 V - 440 V

- Starters are supplied with standard coil voltage 415 Vac
- For other voltages please specify coil code from the below table. (\*suffix code)

## Reversing Starter - HGS Starter

### Features:

- Range : 1.5 kW to 15 kW (2 HP to 20 HP)
- Conforms to IS/IEC 60947-4-1
- Provided with Protection Degree IP 54
- Extended wide band coil
- FRLS (Fire retardant low smoke) Internal wiring
- Starter Type - Air Break Class H Insulation



HSN Code: 85369010

HP	kW	Contactor Size	Overload Relay Range (A)	Item Code	Per Unit LP (₹)
2 HP	1.5 kW	18	2.8 A - 4.2 A	IHHREVKA*	12363.00
3 HP	2.2 kW	18	4.0 A - 6.0 A	IHHREVMA*	
5 HP	3.7 kW	18	6.0 A - 9.0 A	IHHREVPA*	
7.5 HP	5.5 kW	18	8.0 A - 12 A	IHHREVRA*	
10 HP	7.5 kW	18	12 A - 18.0 A	IHHREVTA*	
15 HP	11 kW	32	17 A - 25 A	IHHREVVB*	16710.00
20 HP	15 kW	32	28 A - 40 A	IHHREVXB*	25064.00

### AC Coil

Code*	T	W
AC Voltage	415 V	260 V - 440 V

## Automatic Star Delta Submersible Starter (STD) - HGS Series

### Features:

- Range : 22 kW to 37 kW (30 HP to 50 HP)
- Conforms to IS/IEC 60947-4-1
- Provided with Protection Degree IP 54
- Extended wide band coil
- FRLS (Fire retardant low smoke) Internal wiring
- In-built metering
- Class H Insulation



HSN Code: 85369010

HP	kW	Full load Line Current	Full Load phase current	Contactor Size	Overload Relay Range (A)	Item Code	Per Unit LP (₹)
30 HP	22 kW	43.5	25.12	50	28 A - 40 A	IHHSSDXC*	37842.00
35 HP	26 kW	50.75	29.30	50	34 A - 50 A	IHHSSDYC*A	40098.00
40 HP	30 kW	58	33.49	65	34 A - 50 A	IHHSSDYC*B	44103.00
45 HP	33.6 kW	65.25	37.67	75	45 A - 65 A	IHHSSD1D*	55132.00
50 HP	37 kW	72.5	41.86	85	52 A - 75 A	IHHSSD2D*	60138.00

## Automatic Star Delta Submersible Starter DLX (with short-circuit Protection) - HGS Series

### Features:

- Range : 22 kW to 37 kW (30 HP to 50 HP)
- Conforms to IS/IEC 60947-4-1
- Provided with Protection Degree IP 54
- Extended wide band coil
- FRLS (Fire retardant low smoke) Internal wiring
- In-built metering & MCB
- Class H Insulation













HSN Code: 85369010

HP	kW	Full load Line Current	Full Load phase current	Contactor Size	Overload Relay Range (A)	TP MCB Rating (A)	Item Code	Per Unit LP (₹)
30 HP	22 kW	43.5	25.12	50	28 A - 40 A	100 A	IHHSDXC*	38930.00
35 HP	26 kW	50.75	29.30	50	34 A - 50 A	100 A	IHHSDYC*A	41229.00
40 HP	30 kW	58	33.49	65	34 A - 50 A	100 A	IHHSDYC*B	45309.00
45 HP	33.6 kW	65.25	37.67	75	45 A - 65 A	125 A	IHHSD1D*	56548.00
50 HP	37 kW	72.5	41.86	85	52 A - 75 A	125 A	IHHSD2D*	61650.00

### AC Coil

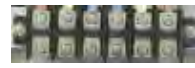
Code*	T	W
AC Voltage	415 V	260 V - 440 V

HSN Code: 85389000

Type	Item Code	Per Unit LP (₹)	
Start Push Button - Green	ICELL00002	201.00	 Start Push Button
Stop Push Button - Red	ICELL00003		 Stop Push Button
Motor ON Indicating Light-Green	ICELKL00015	326.00	 Motor ON Indicating
Motor Trip Indicating Light-Yellow	ICELKL00013		 Motor Trip Indicating
SPP	ISCELXL00063	3432.00	 SPP
Combined Voltmeter & Ammeter	ISCEMLX0007	1340.00	 AV Meter
Terminal Block 6 way	ICELPSMX001	501.00	 TB 6 Way
Terminal Block 3 way	ICELPSMX002	302.00	 TB 3 Way
VOLT.SEL SW. C/G	ICELQL00021	467.00	 Volt Sel Switch
Timer	ICELRPSL005	2957.00	 Timer
Mini Rocker Switch - SPP By Pass	ISCELEL00218	50.00	 Mini Rocker Switch

# Agricultural Motor Starter



**3  $\phi$  DOL Starters**  
Ratings - 0.19 kW to 7.5 kW  
(0.25 HP to 10 HP)



**1  $\phi$  DOL Starters**  
Ratings - 0.37 kW to 2.2 kW  
(0.5 HP to 3 HP)



**3  $\phi$  DOL Starters**  
Ratings - 0.55 kW to 11 kW  
(0.75 HP to 15 HP)



**1  $\phi$  Submersible Starters with Start & Run Capacitor**  
Ratings - 0.37 kW to 2.2 kW  
(0.5 HP to 3 HP)



**3 $\phi$  DOL Submersible Starters**  
Ratings - 0.75 kW to 11 kW  
(1 HP to 15 HP)



**3 $\phi$  ASD Submersible Starters**  
Ratings - 3.7 kW to 15 kW  
(5 HP to 20 HP)



**1  $\phi$  Submersible Pump Controller**  
Ratings - 0.37 kW to 2.2 kW  
(0.5 HP to 3 HP)

# Motor Starter

## urja Urja Lite DOL Starters



### Features:

- Range upto 10 HP DOL
- Wide Band Coil 380 V (250 V - 440 V)
- Enclosure Dust, Vermin & Mpoisture Proof
- Quick Fit Technology
- Hight Electrical & Mechanical Life

HSN Code: 85369010

HP	kW	Contactor	O/L Relay	Motor Starter	
		(A)	(A)	Cat. No.	List Price in ₹ Per Unit
0.25	0.19	12	0.6 A - 1 A	IHADOB1LH	2720.00
0.5	0.37	12	1 A - 1.6 A	IHADOB1LH	2720.00
1	0.75	12	1.5 A - 2.5 A	IHADOB1LH	2720.00
2	1.5	12	2.5 A - 4 A	IHADOB1LH	2720.00
3	2.2	12	4 A - 6.5 A	IHADOB1LH	2720.00
5	3.7	12	6 A - 10 A	IHADOB1LH	2720.00
7.5	5.6	16	9 A - 14 A	IHADOB1LH	2720.00
10	7.5	25	13 A - 21 A	IHADOB1LH	3250.00

Note: Other coil voltages are available on request.

## urja DOL Starters 3 Phase - Agri Series

### Features:

- Range : 0.55 kW to 11 kW (0.75 HP to 15 HP)
- Conforms to IS/IEC 60947-4-1
- Provided with Protection Degree IP 54
- Extended wide band coil
- FRLS (Fire retardant low smoke) Internal wiring
- Starter Type - Air Break
- Class H Insulation



## Direct Online Starter - (Ideal for Agri Pump Application)

HSN Code: 85369010

HP	kW	Contactor	O/L Relay	Motor Starter	
		(A)	(A)	Cat. No.	List Price in ₹ Per Unit
0.75 HP	0.55 kW	16 A	1.07 A -1.7 A	IHAD0AE1*	3330.00
1 HP	0.75 kW	16 A	1.58 A - 2.5 A	IHAD0AF1*	
2 HP	1.5 kW	16 A	2.4 A - 3.8 A	IHAD0AG1*	
3 HP	2.2 kW	16 A	3.8 A - 6.0 A	IHAD0AH1*	
5 HP	3.7 kW	16 A	6.0 A - 9.3 A	IHAD0AJ1*	
7.5 HP	5.5 kW	20 A	8.9 A - 13.5 A	IHAD0AK1*	
		20 A	13.2 A - 20 A	IHAD0AK1*A	
		20 A	17.4 A - 24 A	IHAD0AK1*B	
10 HP	7.5 kW	20 A	13.2 A - 20 A	IHAD0AL1*	4000.00
15 HP	11 kW	25 A	17.4 A - 24 A	IHAD0AM1*	4709.00

### AC Coil

Code*	K
AC Voltage	260 V - 440 V

\*Coil code included in the item code.

## urja DOL Starters Single Phase - Agri Series

### Features:

- Range : 0.37 kW to 2.2 kW (0.5 HP to 3 HP)
- Conforms to IS/IEC 60947-4-1
- Provided with Protection Degree IP 54
- Extended wide band coil
- FRLS (Fire retardant low smoke) Internal wiring
- Starter type Air break
- Class H Insulation



## Direct Online Starter Single Phase

HSN Code: 85369010

HP	kW	FLC (A)	Contactor (A)	O/L Relay (A)	Item Code	Per Unit LP (₹)
0.5 HP	0.37 kW	3.12 A	20 A	3.8 A - 6.0 A	IHUDOLG1F1	2163.00
1 HP	0.75 kW	6.24 A	20 A	6 A - 9.3 A	IHUDOLH1F1	
1.5 HP	1.1 kW	9.15 A	20 A	8.9 A - 13.5 A	IHUDOLK1F1	
2 HP	1.5 kW	12.47 A	20 A	13.2 A - 20 A	IHUDOLK1FA	2222.00
3 HP	2.2 kW	18.71 A	25 A	17.4 A - 24 A	IHUDOLL1F1	

Effective from 11th March, 2024

List Price (LP) are in Indian ₹ & as per Standard Terms & Conditions **HAVELLS 35**

**urja** Direct Online Starter Submersible Pump Controller (Standard)  
3 Phase - Agri Series



**Features:**

- Range : 0.75 kW to 11 kW (1 HP to 15 HP)
- Conforms to IS/IEC 60947-4-1
- Provided with Protection Degree IP 54
- SPP with automanual switch
- FRLS (Fire retardant low smoke) Internal wiring
- Combined V / A meter, Voltmeter selector switch
- ON OFF indication

HSN Code: 85369010

HP	kW	Max. Operational Current (A)	Contactora AC3 (A)	OLR (A)	Cat No.	List Price in ₹ Per Unit
1 HP	0.75 kW	1.90 A	20 A	1.58 A - 2.5 A	IHSDOAF1*A	9606.00
2 HP	1.5 kW	3.81 A	20 A	3.8 A - 6.0 A	IHSDOAH1*A	
3 HP	2.2 kW	5.71 A	20 A	3.8 A - 6.0 A	IHSDOAH1*B	
5 HP	3.7 kW	9.52 A	20 A	8.9 A - 13.5 A	IHSDOAK1*A	
7.5 HP	5.5 kW	14.27 A	20 A	13.2 A - 20 A	IHSDOAL1*A	
10 HP	7.5 kW	19.03 A	25 A	13.2 A - 20 A	IHSDOAL1*B	10105.00
12.5 HP	9.3 kW	23.79 A	32 A	17.4 A - 24 A	IHSDOAM1*A	10610.00
15 HP	11 kW	28.55 A	32 A	22 A - 30 A	IHSDOAN1*A	11779.00

**urja** Automatic Star Delta Submersible Pump Controller (Standard)  
3 Phase - Agri Series



**Features:**

- Range : 0.75 kW to 11 kW (1 HP to 15 HP)
- Conforms to IS/IEC 60947-4-1
- Provided with Protection Degree IP 54
- SPP with automanual switch
- FRLS (Fire retardant low smoke) Internal wiring
- Combined V / A meter, Voltmeter selector switch
- ON OFF indication
- Star Delta Timer

HSN Code: 85369010

HP	Max Operating Current 135% (A)	Phase Current (A)	OLR (A)	Contactora AC3 (A)	Cat. No.	List Price in ₹ Per Unit
5 HP	10.13 A	5.85 A	3.8 A - 6.0 A	20 A	IHSASAH1*A	16873.00
7.5 HP	15.19 A	8.77 A	6 A - 9.3 A	20 A	IHSASAJ1*A	
10 HP	20.25 A	11.69 A	8.9 A - 13.5 A	20 A	IHSASAK1*A	
12.5 HP	25.31 A	14.61 A	13.2 A - 20 A	20 A	IHSASAL1*A	18339.00
15 HP	30.38 A	17.54 A	13.2 A - 20 A	20 A	IHSASAL1*B	18739.00
17.5 HP	35.44 A	20.46 A	17.4 A - 24 A	25 A	IHSASAM1*A	
20 HP	40.50 A	23.38 A	22 A - 30 A	32 A	IHSASAN1*A	21472.00

**AC Coil**

Code*	K
AC Voltage	260 V - 440 V

\*To complete the Cat no. suffix the coil voltage from the coil voltage table

# POWER GUARD Submersible Controllers (Standard)

NEW



## Features:

- Water Filled / Oil Filled Submersible motor Configuration
- Digital Smart display for clear identification of current and voltage
- OLP, MCB & contactor combination for better efficiency & performance against product safety
- Applicable for 75 mm / 100 mm borewell Submersible Pump application
- Suitable for wide voltage operation
- High quality rubber gasket to prevent dust entry
- Five-way connector for easy connection

HSN Code: 85369010

Item Code	kW	HP	Type	Descriptions	OLP	MCB	Contactor	Run	Start	Per Unit LP (₹)
IHQMFDM1F1	0.37	0.5	water Filled	0.5 HP SP STR WATER FILLED R6A	6 A	10 A	20 A	36	120 - 150	3410.00
IHRMFDM1F1	0.37	0.5	Oil Filled	0.5 HP SP STR OIL FILLED R6A	6 A	10 A	20 A	36	0	3190.00
IHQMFQ1F1	0.75	1	water Filled	1 HP SP STR WATER FILLED R 10A	10 A	16 A	20 A	50	120 - 150	3482.00
IHRMFQ1F1	0.75	1	Oil Filled	1 HP SP STR OIL FILLED R10A	10 A	16 A	20 A	36	0	3372.00
IHSMFQ1F1	0.75	1	Oil Filled	1 HP SP STR OIL FILLED WC R10A	10 A	16 A	0 A	36	0	1909.00
IHQMFDR1F1	1.1	1.5	water Filled	1.5 HP SP STR WATER FILLED R 12A	16 A	20 A	25 A	72	150 - 200	3768.00
IHRMFDR1F1	1.1	1.5	Oil Filled	1.5 HP SP STR OIL FILLED R12A	16 A	20 A	25 A	50	0	3575.00
IHSMFDR1F1	1.1	1.5	Oil Filled	1.5 HP SP STR OIL FILLED WC R12A	12 A	20 A	0 A	50	0	2019.00
IHQMFD1FA	1.1	1.5	Water Filled	1.5 HP SP STR WATER FILLED R14A	16 A	20 A	25 A	50+50	150 - 200	3850.00
IHQMFU1F1	1.5	2	Water Filled	2 HP SP STR WATER FILLED R 16A	16 A	20 A	25 A	72	150 - 200	3933.00
IHQMFU1FA	1.5	2	Water Filled	2 HP SP STR WATER FILLED R16A CAP 50+50	16 A	20 A	25 A	50+50	150 - 200	4015.00
IHRMFU1F1	1.5	2	Oil Filled	2 HP SP STR OIL FILLED R16A	16 A	20 A	25 A	72	0	3762.00
IHQMFV1F1	2.2	3	water Filled	3 HP SP STR WATER FILLED R 25A	25 A	32 A	32 A	50 + 50	200 - 250	4538.00

# POWER GUARD Submersible Controllers (Deluxe)



## Features:

- Inbuilt start run capacitor
- Suitable for wide voltage operation
- High quality rubber gasket to prevent dust entry
- Five-way connector for easy connection
- OLR with Single Phasing Protection

HSN Code: 85369010

HP Rating	kW	Overload Relay (A)	Contactor (A)	Start Capacitor $\mu$ F (MFD)	Run Capacitor $\mu$ F (MFD)	Cat No.	List Price in ₹ Per Unit
0.5 HP	0.37 kW	3.8 A - 6.0 A	20 A	80 $\mu$ F - 100 $\mu$ F	25 $\mu$ F	IHADOAH1F1	5329.00
0.5 HP	0.37 kW	3.8 A - 6.0 A	20 A	80 $\mu$ F - 100 $\mu$ F	36 $\mu$ F	IHADOAJ1FA	
1 HP	0.75 kW	6 A - 9.3 A	20 A	100 $\mu$ F - 120 $\mu$ F	36 $\mu$ F	IHADOAJ1FB	
1 HP	0.75 kW	6 A - 9.3 A	20 A	100 $\mu$ F - 120 $\mu$ F	50 $\mu$ F	IHADOAJ1FC	
1 HP	0.75 kW	6 A - 9.3 A	20 A	120 $\mu$ F - 150 $\mu$ F	50 $\mu$ F	IHADOAJ1FD	5880.00
1.5 HP	1.1 kW	8.9 A - 13.5 A	20 A	120 $\mu$ F - 150 $\mu$ F	50 $\mu$ F	IHADOAK1FA	
1.5 HP	1.1 kW	8.9 A - 13.5 A	20 A	150 $\mu$ F - 200 $\mu$ F	36+36 $\mu$ F	IHADOAK1FB	
2 HP	1.5 kW	13.2 A - 20 A	20 A	150 $\mu$ F - 200 $\mu$ F	36+36 $\mu$ F	IHADOAL1FA	6287.00
2 HP	1.5 kW	13.2 A - 20 A	20 A	150 $\mu$ F - 200 $\mu$ F	50+50 $\mu$ F	IHADOAL1FB	
2 HP	1.5 kW	13.2 A - 20 A	20 A	200 $\mu$ F - 250 $\mu$ F	50+36 $\mu$ F	IHADOAL1FC	
3 HP	2.2 kW	17.4 A - 24 A	25 A	200 $\mu$ F - 250 $\mu$ F	50+50 $\mu$ F	IHADOAM1FA	7457.00
3 HP	2.2 kW	17.4 A - 24 A	25 A	200 $\mu$ F - 250 $\mu$ F	50+36+36 $\mu$ F	IHADOAM1FB	

## AC Coil

Code*	F
AC Voltage	140 V - 270 V

\*Coil code included in the item code

Effective from 11th March, 2024

List Price (LP) are in Indian ₹ & as per Standard Terms & Conditions **HAVELLS 37**

## urja Contactor 4 Pole (16 A to 40 A)



### Features:

- Rugged Contactors with heavy duty Contacts with anti-welding silver alloys
- High Mechanical and Electrical Life
- High Terminal Capacity
- Suitable for Wide voltage Fluctuations including sudden DIP in voltage

HSN Code: 85369010

AC-3 Duty Rating at 415 V, 50 Hz I <sub>e</sub> (A)	AC-1 Duty Rating at 415 V, 50 Hz I <sub>th</sub> (A)	Power Poles	Type	Item Code	Item Description	Per Unit LP (₹)
16 A	20 A	4	UC1 16 F	IHPBC016100*	16 A 4P Contactor	2950.00
20 A	25 A		UC1 20 F	IHPBC020100*	20 A 4P Contactor	3600.00
25 A	40 A		UC1 25 F	IHPBC025100*	25 A 4P Contactor	4500.00
32 A	45 A		UC1 32 F	IHPBC032100*	32 A 4P Contactor	4800.00
40 A	63 A		UC1 40 F	IHPBC040100*	40 A 4P Contactor	7000.00

## urja Contactor 2 Pole (16 A to 40 A)



### Features:

- Rugged Contactors with heavy duty Contacts with anti-welding silver alloys
- High Mechanical and Electrical Life
- High Terminal Capacity
- Suitable for Wide voltage Fluctuations including sudden DIP in voltage

HSN Code: 85369010

AC-3 Duty Rating at 415 V, 50 Hz I <sub>e</sub> (A)	AC-1 Duty Rating at 415 V, 50 Hz I <sub>th</sub> (A)	Power Poles	Type	Item Code	Item Description	Per Unit LP (₹)
20 A	32 A	2	UC1 20 D	IHPBF020100*	20 A 2P Contactor	1368.00
25 A	40 A		UC1 25 D	IHPBF025100*	25 A 2P Contactor	1950.00
40 A	63 A		UC1 40 D	IHPBF040100*	40 A 2P Contactor	2673.00

\*To complete the Cat no. suffix the coil voltage from the coil voltage table

### AC Coil for 4 Pole

Code*	F	K
AC Voltage	140 V - 270 V	260 V - 440 V

### AC Coil for 2 Pole

Code*	F
AC Voltage	140 V - 270 V



## urja Thermal Overload Relay 3 Pole

HSN Code: 85364900

Relay Range (A)	Suitable for	Poles	Type	Item Code	Item Description	Per Unit LP (₹)
1.07 A - 1.7 A	4 Pole Contactors	3	UR1 E	IHAR13CE	3P Thermal O/L Relay A/M	1793.00
1.58 A - 2.5 A			UR1 F	IHAR13CF	3P Thermal O/L Relay A/M	
2.4 A - 3.8 A			UR1 G	IHAR13CG	3P Thermal O/L Relay A/M	
3.8 A - 6.0 A			UR1 H	IHAR13CH	3P Thermal O/L Relay A/M	
6 A - 9.3 A			UR1 J	IHAR13CJ	3P Thermal O/L Relay A/M	
8.9 A - 13.5 A			UR1 K	IHAR13CK	3P Thermal O/L Relay A/M	
13.2 A - 20 A			UR1 L	IHAR13CL	3P Thermal O/L Relay A/M	
17.4 A - 24 A			UR1 M	IHAR13CM	3P Thermal O/L Relay A/M	
22 A - 30 A			UR1 N	IHAR13CN	3P Thermal O/L Relay A/M	

## urja Thermal Overload Relay 2 Pole



HSN Code: 85364900

Relay Range (A)	Suitable for	Poles	Type	Item Code	Item Description	Per Unit LP (₹)
3.8 A - 6 A	2 Pole Contactors	2	UR1 H	IHAR12CH	2P Thermal O/L Relay A/M	927.00
6 A - 9.3 A			UR1 J	IHAR12CJ	2P Thermal O/L Relay A/M	
8.9 A - 13.5 A			UR1 K	IHAR12CK	2P Thermal O/L Relay A/M	
13.2 A - 20 A			UR1 L	IHAR12CL	2P Thermal O/L Relay A/M	1012.00
17.4 A - 24 A			UR1 M	IHAR12CM	2P Thermal O/L Relay A/M	
22 A - 30 A			UR1 N	IHAR12CN	2P Thermal O/L Relay A/M	

**Spare Agri Contactor 2P / 4P**

HSN Code: 85389000

Type	Rating	Item Code	Per Unit LP (₹)
Housing 2P		ISCPMPXCX016	326.00
Housing 4P		ISCPMPXCX014	526.00
Carrier Assembly 2P		ISSPEX0447	94.00
Carrier Assembly 4P		ISSPEX0446	136.00
2P Contactor Coil	140 V - 270 V	ISSPEP0008	701.00
4P Contactor Coil	200 V - 400 V	ISSPEP0007	801.00
	415 V (260 V - 440 V)	ISSPEP0009	
	240 V (140 V - 270 V)	ISSPEP0011	
Single Fixed Contact 2P / 4P	20 A	ISSPEX0428	110.00
	25 A	ISSPEX0429	149.00
	32 A	ISSPEX0430	159.00
	40 A	ISSPEX0439	191.00
Single Moving Contact 2P / 4P	20 A	ISSPEX0431	166.00
	25 A	ISSPEX0432	235.00
	32 A	ISSPEX0433	267.00
	40 A	ISSPEX0440	326.00
Contact Kit 2P Contactor	20 A	ISSPEX0441	751.00
	25 A	ISSPEX0442	1056.00
	40 A	ISSPEX0444	1391.00
Contact Kit 4P Contactor	20 A	ISSPEX0434	1364.00
	25 A	ISSPEX0435	2123.00
	32 A	ISSPEX0436	2282.00
	40 A	ISSPEX0445	2274.00



**DOL Starter - Spares**

HSN Code: 85389000

Type	Item Code	Per Unit LP (₹)
NO Switch URJA	ISSPEX0437	159.00
ON / OFF Push Button Assembly URJA	ISSPEX0438	



NO Switch



ON / OFF PB

**urja** Single Phase Sub. Starter - Spares

HSN Code: 85389000

Type	Item Code	Per Unit LP (₹)	
PB Red for SPSS with 1NC Element	ISCELXLX0001	235.00	
5+16 Element (1.5-2 HP) 1.12 kW - 1.50 kW	ISCELXLX0002	443.00	
	5+25 Element (3-5 HP) 2.24 kW - 3.73 kW	ISCELXLX0003	509.00
Neon Light Indicator Red	ISCELKLX0006	94.00	
Front Add-on Aux.Cont.Blck	2NO ISSPEX0427	501.00	
Combined AV Meter	30 A - 300 V	ISCELMLX0006	1334.00
	25 A - 500 V	ISCELMLX0007	1340.00
	50 A - 500 V	ISCELMLX0008	1475.00
Terminal Block	2 Way SPSS	ISCPMPSX032	50.00
	5 Way	ISCELXPX0003	184.00



PB Red



PB Green



Neon Light



Front Add-on



AV Meter



TB 2Way



TB 5Way

Type	Item Code	Per Unit LP (₹)		
Start Push Button - Green	ICELL00002	201.00		Start Push Button
Stop Push Button - Red	ICELL00003			Stop Push Button
Motor ON Indicating Light-Green	ICELKL00015	326.00		Motor ON Indicating
Motor Trip Indicating Light-Yellow	ICELKL00013			Motor Trip Indicating
SPP	ISCELXL00063	3432.00		SPP
Combined Voltmeter & Ammeter	ISCELMLX0007	1340.00		AV Meter
Terminal Block 6 way	ICELPSMX001	501.00		TB 6 Way
Terminal Block 3 way	ICELPSMX002	302.00		TB 3 Way
VOLT.SEL SW. C/G	ICELQL00021	467.00		Volt Sel Switch
Timer	ICELRPSL005	2957.00		Timer
Front Block 1NO 1NC	ISPNAFM711	526.00		Front Block
Mini Rocker Switch - SPP By Pass	ISCELEL00218	50.00		Mini Rocker Switch

# Street Light Panel



## HGS Smarty Series

### Features:

- Range : 6 kW to 12 kW
- Conforms to IS/IEC 61439 & 60529
- Provided with Protection Degree IP 54
- Extended wide band coil
- FRLS (Fire retardant low smoke) Internal wiring
- In-built Short-Circuit Protection
- Class H Insulation

HSN Code: 85365090

			Digital 24 Hour Switch		Astronomical Switch		
Phase	Max. Load (kW)	Contactor Rating (A)	MCB Rating	Item Code	Per Unit	Item Code	Per Unit LP (₹)
3	6 kW	32 A TP	40 A TPN	IHXTS03060	32860	IHXTS0306A	33860.00
	12 kW	65 A TP	63 A TPN	IHXTS09120	50704	IHXTS0912A	51704.00
1	6 kW	32 A TP	40 A SPN	IHXSS01060	24639	IHXSS0106A	25639.00
	12 kW	65 A TP	63 A SPN	IHXSS03120	37023	IHXSS0312A	38023.00

HSN Code: 85389000

Description	Item Code	Per Unit LP (₹)
PROGRAMMABLE TIME SWITCH FOR SLP	ISCEMLX0012	3569.00
ASTRONOMICAL TIME SWITCH FOR SLP	ISCEMLX0013	3858.00

For customised Street Lighting Panels, contact to nearest branch



## Powergear



# ACB Ordering Code Logic

1, 2, 3	4	5	6	7	8, 9	10		11, 12		13
Product	Pole	Breaking Capacity	Mounting Type	IPR	Rating	Closing Coil & Charging Motor		SHT & UVT		Current Transformer
						CC (voltage)	CM (voltage)	UVT (Voltage)	SHT (Voltage)	
IHA	T	E	Manual Fixed = 1	Bus Coupler = 0	400A = 04	24	220 = A	415	24 = 01	If rating same as ACB rating then = 0
	TP	50KA	Manual Drawout = 2	IPR 1 = 1	630A = 06	110	220 = B	415	110 = 02	400A = A
	F	S	Electrical Fixed = 4	IPR 3 = 3	800A = 08	220	220 = C	415	220 = 03	630A = B
	FP	65KA	Electrical Drawout = 5	IPR 5 = 5	1000A = 10	415	220 = D	415	415 = 04	800A = C
		H		IPR E = E	1250A = 12	24	110 = E	415	0 = 05	1000A = D
		75KA			1600A = 16	110	110 = F	220	24 = 06	1250A = E
					2000A = 20	220	110 = G	220	110 = 07	1600A = F
					2500A = 25	415	110 = H	220	220 = 08	2000A = G
						Not req.	Not req. = 0	220	415 = 09	2500A = H
								220	0 = 10	3200A = I
								110	24 = 11	4000A = J
								110	110 = 12	5000A = K
								110	220 = 13	6300A = L
								110	415 = 14	
								110	0 = 15	
								24	24 = 16	
								24	110 = 17	
								24	220 = 18	
								24	415 = 19	
								24	0 = 20	
								0	24 = 21	
								0	110 = 22	
								0	220 = 23	
								0	415 = 24	

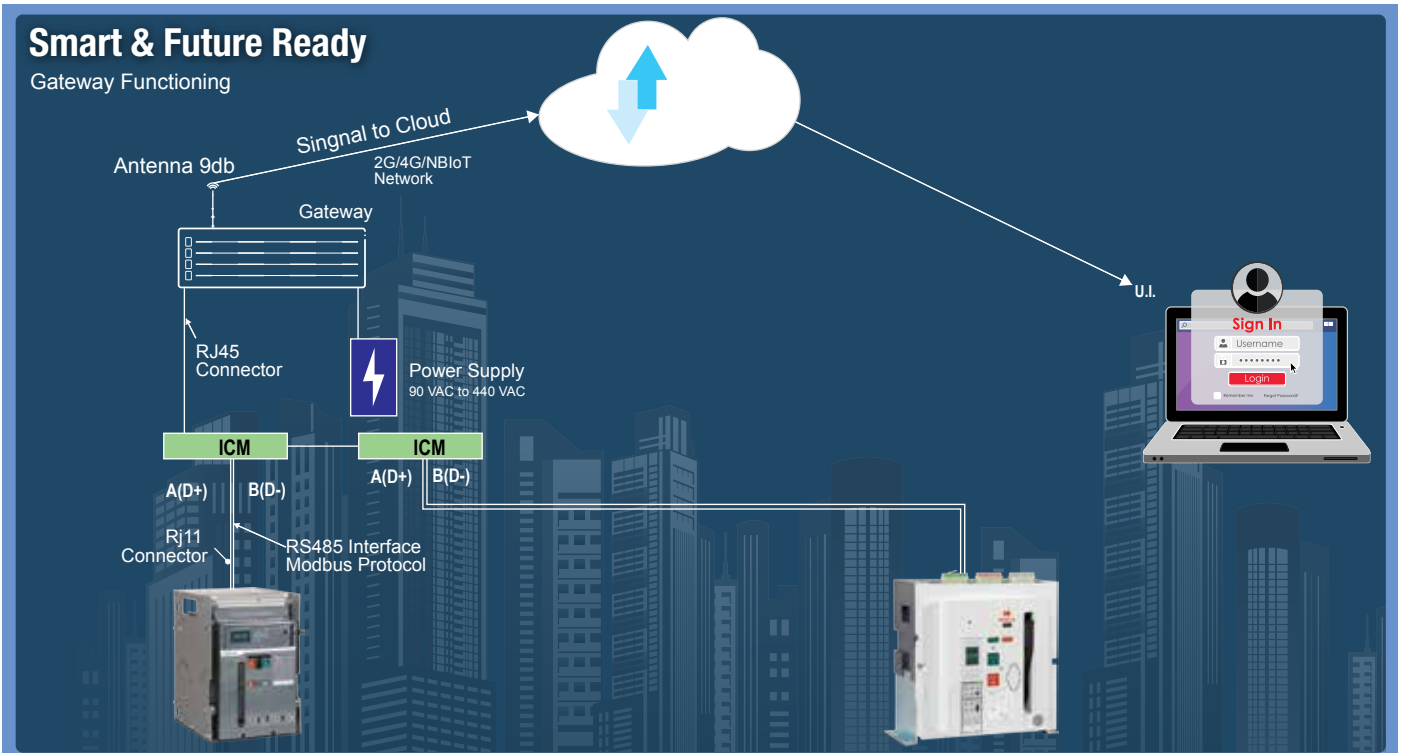



# Titania

Air Circuit Breaker

400 A – 2500 A



Breaking Capacity @ 415 V	E Frame	S Frame	H Frame
	<b>400 A - 2000 A</b>	<b>400 A - 2000 A</b>	<b>2500 A</b>
<b>Ics=100% Icu</b>	<b>50 kA</b>	<b>65kA</b>	<b>75kA</b>
<b>Icw for 1 s</b>	<b>50kA</b>	<b>50kA</b>	<b>65kA</b>





# Titania+

Air Circuit Breaker

630 A – 6300 A



**NEW**

Breaking Capacity @ 415 V	A Frame	AA Frame	B Frame	C Frame	D Frame
	<b>630 A - 1600 A</b>	<b>2000 A - 2500 A</b>	<b>3200 A - 4000 A</b>	<b>5000 A</b>	<b>6300 A</b>
<b>Ics=100% Icu</b>	<b>65 kA</b>	<b>85 kA</b>	<b>100 kA</b>	<b>100 kA</b>	<b>150 kA</b>
<b>Icw for 1 s</b>	<b>50 kA</b>	<b>70 kA</b>	<b>85 kA</b>	<b>85 kA</b>	<b>100 kA</b>



# Titania Air Circuit Breaker

(Conforms to IS/IEC:60947-2)



## 3 Pole ACB with Microprocessor Release IPR 1+

Current Rating	Rated Ultimate Short-circuit Breaking Capacity Ics = 100 % Icu at	MANUAL				ELECTRICAL*	
		Item Code	Per Unit LP (₹)	Item Code	Per Unit LP (₹)	Item Code	
(A)	415 V (kA)	Fixed		Drawout		Fixed	Drawout
630 A	50 kA	IHATE11060**#	141390.00	IHATE21060**#	183810.00	IHATE4106\$**#	IHATE5106\$**#
800 A	50 kA	IHATE11080**#	141390.00	IHATE21080**#	183810.00	IHATE4108\$**#	IHATE5108\$**#
1000 A	50 kA	IHATE11100**#	144140.00	IHATE21100**#	187380.00	IHATE4110\$**#	IHATE5110\$**#
1250 A	50 kA	IHATE11120**#	160990.00	IHATE21120**#	202725.00	IHATE4112\$**#	IHATE5112\$**#
1600 A	50 kA	IHATE11160**#	175575.00	IHATE21160**#	220615.00	IHATE4116\$**#	IHATE5116\$**#
2000 A	50 kA	IHATE11200**#	202725.00	IHATE21200**#	266220.00	IHATE4120\$**#	IHATE5120\$**#

## 3 Pole ACB with Microprocessor Release IPR 1+

Current Rating	Rated Ultimate Short-circuit Breaking Capacity Ics = 100 % Icu at	MANUAL				ELECTRICAL*	
		Item Code	Per Unit LP (₹)	Item Code	Per Unit LP (₹)	Item Code	
(A)	415 V (kA)	Fixed		Drawout		Fixed	Drawout
630 A	65 kA	IHATS11060**#	153910.00	IHATS21060**#	236970.00	IHATS4106\$**#	IHATS5106\$**#
800 A	65 kA	IHATS11080**#	153910.00	IHATS21080**#	236970.00	IHATS4108\$**#	IHATS5108\$**#
1000 A	65 kA	IHATS11100**#	161060.00	IHATS21100**#	256085.00	IHATS4110\$**#	IHATS5110\$**#
1250 A	65 kA	IHATS11120**#	199350.00	IHATS21120**#	289060.00	IHATS4112\$**#	IHATS5112\$**#
1600 A	65 kA	IHATS11160**#	210975.00	IHATS21160**#	314355.00	IHATS4116\$**#	IHATS5116\$**#
2000 A	65 kA	IHATS11200**#	226575.00	IHATS21200**#	333900.00	IHATS4120\$**#	IHATS5120\$**#
2500 A	75 kA	IHATH11250**#	262845.00	IHATH21250**#	391640.00	IHATH4125\$**#	IHATH5125\$**#

\* Please refer table A to Product price list  
 To replace \$ Please refer table 1 at page-51  
 To replace \*\* Please refer table 2 at page-51  
 To replace # Please refer table 3 at page-51  
 Door Flange (Escutcheon Frame) is supplied alongwith ACB

# Titania Air Circuit Breaker

(Conforms to IS/IEC:60947-2)



## 4 Pole ACB with Microprocessor Release IPR 1+

Current Rating	Rated Ultimate Short-circuit Breaking Capacity Ics = 100 % Icu at	MANUAL				ELECTRICAL*	
		Item Code	Per Unit LP (₹)	Item Code	Per Unit LP (₹)	Item Code	
(A)	415 V (kA)	Fixed		Drawout		Fixed	Drawout
630 A	50 kA	IHAFE11060**#	179010.00	IHAFE21060**#	227370.00	IHAFE4106\$**#	IHAFE5106\$**#
800 A	50 kA	IHAFE11080**#	179010.00	IHAFE21080**#	227370.00	IHAFE4108\$**#	IHAFE5108\$**#
1000 A	50 kA	IHAFE11100**#	186955.00	IHAFE21100**#	243040.00	IHAFE4110\$**#	IHAFE5110\$**#
1250 A	50 kA	IHAFE11120**#	197755.00	IHAFE21120**#	257075.00	IHAFE4112\$**#	IHAFE5112\$**#
1600 A	50 kA	IHAFE11160**#	219245.00	IHAFE21160**#	282395.00	IHAFE4116\$**#	IHAFE5116\$**#
2000 A	50 kA	IHAFE11200**#	259480.00	IHAFE21200**#	336285.00	IHAFE4120\$**#	IHAFE5120\$**#

## 4 Pole ACB with Microprocessor Release IPR 1+

Current Rating	Rated Ultimate Short-circuit Breaking Capacity Ics = 100 % Icu at	MANUAL				ELECTRICAL*	
		Item Code	Per Unit LP (₹)	Item Code	Per Unit LP (₹)	Item Code	
(A)	415 V (kA)	Fixed		Drawout		Fixed	Drawout
630 A	65 kA	IHAFS11060**#	193945.00	IHAFS21060**#	334780.00	IHAFS4106\$**#	IHAFS5106\$**#
800 A	65 kA	IHAFS11080**#	193945.00	IHAFS21080**#	334780.00	IHAFS4108\$**#	IHAFS5108\$**#
1000 A	65 kA	IHAFS11100**#	224490.00	IHAFS21100**#	343470.00	IHAFS4110\$**#	IHAFS5110\$**#
1250 A	65 kA	IHAFS11120**#	257160.00	IHAFS21120**#	393450.00	IHAFS4112\$**#	IHAFS5112\$**#
1600 A	65 kA	IHAFS11160**#	301050.00	IHAFS21160**#	460610.00	IHAFS4116\$**#	IHAFS5116\$**#
2000 A	65 kA	IHAFS11200**#	321975.00	IHAFS21200**#	470110.00	IHAFS4120\$**#	IHAFS5120\$**#
2500 A	75 kA	IHAFH11250**#	345825.00	IHAFH21250**#	480765.00	IHAFH4125\$**#	IHAFH5125\$**#

## Titania +

Rating	Pole	MANUAL		ELECTRICAL	
		Fixed	Drawout	Fixed	Drawout
400 A - 1600 A	4 Pole		POR		POR
2000 A - 2500 A					
3200 A	3 Pole / 4 Pole	Price on Request			
4000 A					
5000 A					
6300 A					



\* Please refer table A to Product price list  
 To replace \$ Please refer table 1 at page-51  
 To replace \*\* Please refer table 2 at page-51  
 To replace # Please refer table 3 at page-51

## Table - A

List prices Charges for product different version wrt IPR1+ ACB List Price		Per Unit LP (₹)
Bus Coupler w/o Protection	Reduce	20710.00
Micro processor release IPRE+ ( LI)	Reduce	8975.00
Micro processor release IPR3+ ( LSI+ LCD Display+Thermal Memory+ Zone selectivity+ Current & Voltage Mesurment+ Advance protection +Over Tempeture Protection)	Add	29090.00
Micro processor release IPR5+( LCD Display+Thermal Memory+ Zone selectivity+ Advance protection+ Advance Mesurment Over Tempeture Protection+ Maximum Demand + Comunication)	Add	40495.00
To Convert Electrical version from Manual version (includes Motor, Shunt trip & Closing Coil)	Add	45925.00

## 1. Communication Software

HSN Code: 85389000

S.No.	SAP Code	Description	Per Unit LP (₹)
1	SACX0346	Communication software for IRP-5+	POR

## 2. Spring Charging Motor

HSN Code: 85389000

S.No.	SAP Code	Description	Per Unit LP (₹)
1	ISACX0358	Charging Motor 110 V	38845.00
2	ISACX0147	Charging Motor 230 V	38845.00

## 3. Main CT's

HSN Code: 85389000

S.No.	SAP Code	Description	Per Unit LP (₹)
1	ICELFACL018	CT 400 A	3355.00
2	ICELFACL001	CT 630 A	3355.00
3	ICELFACL002	CT 800 A	3355.00
4	ICELFACL003	CT 1000A	3535.00
5	ICELFACL004	CT 1250 A	3535.00
6	ICELFACL005	CT 1600 A	3535.00
7	ICELFACL006	CT 2000 A	4745.00
8	ICELFACL007	CT 2500A	4745.00

## 4. Neutral CTs

HSN Code: 85389000

S.No.	SAP Code	Description	Per Unit LP (₹)
1	ICELFACL019	NCT 400 A	3355.00
2	ICELFACL012	NCT 630 A	3355.00
3	ICELFACL013	NCT 800 A	3355.00
4	ICELFACL014	NCT 1000A	3535.00
5	ICELFACL015	NCT 1250 A	3535.00
6	ICELFACL016	NCT 1600 A	3535.00
7	ICELFACL017	NCT 2000 A	4745.00
8	ICELFACL021	NCT 2500A	4745.00



Undervoltage release

## 5. Under Voltage Trip Device (UVT)

HSN Code: 85389000

S.No.	SAP Code	Description	Per Unit LP (₹)
1	ISACX0196	220 VAC	4975.00
2	ISACX0197	415 VAC	4975.00



Shunt Trip Coil / Closing Coil

## 6. Shunt Trip / Closing Coil

HSN Code: 85389000

S.No.	SAP Code	Description	Per Unit LP (₹)
1	ISACX0170	24 VDC	3540.00
2	ISACX0168	110 VAC/DC	3540.00
3	ISACX0167	220 VAC/DC	3540.00
4	ISACX0212	415 VAC	3540.00

# Titania Air Circuit Breaker

(Conforms to IS/IEC:60947-2)



ON/OFF push button cover



Door Interlock



Drawout position lock



Adaptor terminals for Cradle

## 7. Key Lock / Key Interlock

HSN Code: 85389000

S.No.	SAP Code	Description	Per Unit LP (₹)
1	ISACX0301	On/Off Button cover	450.00
2	ISACX0353	Key lock (1 lock+1 key)	1820.00
3	ISACX0181	Key interlock (2 locks+1 keys)	2545.00
4	ISACX0210	Key interlock (3 locks+2 keys)	5365.00
5	ISACX0341	Drawout position Lock	2210.00

## 8. Adaptor Type Terminals (additional price)

(6 nos. reqd. for 3 pole & 8 nos. for 4 pole ACB)

HSN Code: 85389000

S.No.	SAP Code	Description	Per Unit LP (₹)
1	ISSACX0174	630/800 A	4795.00
2	ISSACX0164	1000/1250 A	5270.00
3	ISSACP0434	1600 A	7455.00

## 9. Other Accessories

HSN Code: 85389000

S.No.	SAP Code	Description	Per Unit LP (₹)
1	ISACX0208	Door Interlock	3240.00
2	ISACX0028	Close open cycle counter	3190.00

\*ACBs are supplied with following accessories as standard fitment:

Manual Fixed	Manual Drawout	Electrical Fixed	Electrical Drawout
Aux. Contact Unit 5CO	Aux. Contact Unit 5CO Safety Shutter Aux. Isolating contact unit Horizontal Terminals	Horizontal Terminals Shunt Trip Device Charging Motor Closing Coil	Aux. Contact Unit 5CO Safety Shutter Aux. Isolating contact unit Horizontal Terminals Shunt Trip Device Charging Motor Closing Coil



Position Indication Switch



Auxiliary Contacts

\*Additional accessories except standard fitment are available on extra price.

\*Neutral CT is supplied as a standard fitment in 4 Pole ACBs.

\*Neutral CT prices are to be added for 3 Pole ACBs for ground fault protection.

\*All orders should be accompanied with ACB order form included in catalogue.

\*1 This CT is required for GFT in 3 pole ACBs for 4 Pole ACBs main CTs is used as neutral CT.

## 10. Other Accessories

HSN Code: 85389000

S.No.	SAP Code	Description	Per Unit LP (₹)
1	ISACX0207	Spring charge indication switch	2115.00
2	ISACX0349	Trip indication Switch	1335.00
3	ISACX0139	Aux. switch (5 c/o additional)	3250.00
4	ISACX0182	Position indication switch	2325.00
5	ISACX0302	Field test unit	3120.00

## Table 1

Closing Coil & Charging Motor		
CC (Voltage)	CM (Voltage)	\$
24 V	220 V	A
110 V	220 V	B
220 V	220 V	C
415 V	220 V	D
24 V	110 V	E
110 V	110 V	F
220 V	110 V	G
415 V	110 V	H

## Table 2

UVT & SHT		
UVT (Voltage)	SHT (Voltage)	**
415 V	24 V	01 (Zero one)
415 V	110 V	02
415 V	220 V	03
415 V	415 V	04
415 V	0	05
220 V	24 V	06
220 V	110 V	07
220 V	220 V	08
220 V	415 V	09
220 V	0	10
110 V	24 V	11
110 V	110 V	12
110 V	220 V	13
110 V	415 V	14
110 V	0	15
24 V	24 V	16
24 V	110 V	17
24 V	220 V	18
24 V	415 V	19
24 V	0	20
0	24 V	21
0	110 V	22
0	220 V	23
0	415 V	24
0	0	00 (Zero Zero)

## Table 3

Current Transformer	#
CT Rating is same as of ACB	0 (Zero)
400 A	A
630 A	B
800 A	C
1000A	D
1250 A	E
1600 A	F
2000 A	G

# Titania Air Circuit Breaker

(Conforms to IS/IEC:60947-2)

## Intelligent Protection Releases

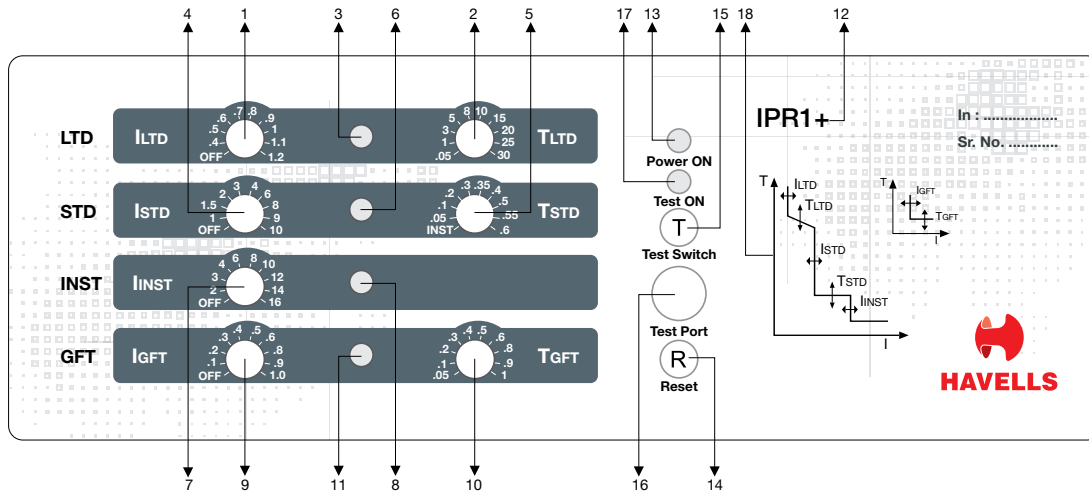

Ref.	Description	Ref.	Description
1	Rotary switch for setting LTD current	10	Rotary switch for setting GFT time
2	Rotary switch for setting LTD Time	11	LED indication for GFT fault
3	LED indication for LTD fault	12	Product identification code
4	Rotary switch for setting STD current	13	LED for "Power ON"
5	Rotary switch for setting STD time	14	Reset push button
6	LED indication for STD fault	15	Test push button
7	Rotary switch for setting INST current	16	Socket for test supply
8	LED indication for INST fault	17	LED for "Test ON"
9	Rotary switch for setting GFT current	18	Time current characteristics curve

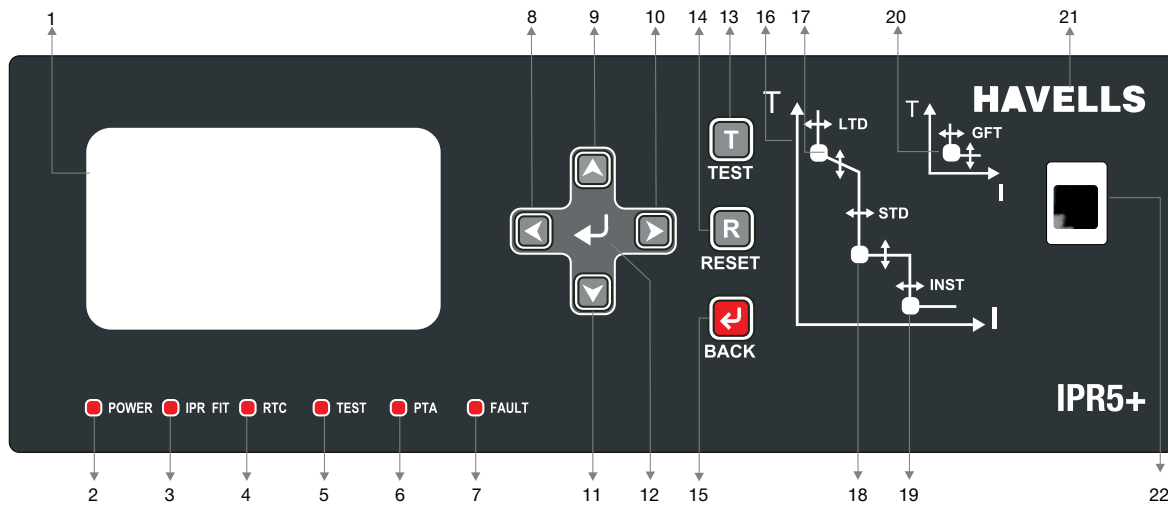

Ref.	Description	Ref.	Description
1	LCD Screen	12	Enter / Save Push Button
2	LED for "Power ON"	13	Test Push Button
3	LED for "IPR Fit"	14	Reset Push Button
4	#LED for "RTC (Ready to Close)"	15	Back Push Button
5	LED for "Test ON"	16	Time Current Characteristic Curve
6	LED for "PTA (Pre-Trip Alarm)"	17	LED Indication for LTD Fault
7	LED for "Faults"	18	LED Indication for STD Fault
8	Scroll "Left" Push Button	19	LED Indication for INST Fault
9	Scroll "Up" Push Button	20	LED Indication for GFT Fault
10	Scroll "Right" Push Button	21	Product Identification Code
11	Scroll "Down" Push Button	22	MODBUS RS-485 Communication Port

# Titania Air Circuit Breaker

(Conforms to IS/IEC:60947-2)

## New Range of Intelligent Protection Release (IPR)+ (400 A - 2500 A)



S. No.	Features	IPR E+	IPR 1+	IPR 3+	IPR 5+
	Release settings:	●	●	●	●
1	LTD	Current Setting	●	●	●
		Time Setting	●	●	●
2	STD	Current Setting	●	●	●
		Time Setting	●	●	●
3	INST	●	●	●	●
4	GFT	Current Setting	●	●	●
		Time Setting	●	●	●
5	PTA	Current Setting		●	●
		Time Setting		●	●
6	Function Blocking	●	●	●	●
7	Field Test Function	●	●	●	●
8	IPR Fit Indicator			●	●
9	Load Shedding Function			●	●
10	Reset Function	●	●	●	●
11	Thermal Memory			●	●
12	LED Indications	●	●	●	●
13	Fault History on Display			●	●
14	Making Current Release	●	●	●	●
15	Zone Selectivity			●	●
16	Circuit Breaker Fail Protection			●	●
17	Operation Counter			●	●
18	Contact Erosion Indicator			●	●
19	Ready to Close (RTC)*			●	●
20	I2t ON/OFF			●	●
21	LCD Display			●	●
22	Bar Graphs Indication			●	●
23	External Relay Card*			●	●
	Advanced Protection			●	●
24	Under Voltage Release			●	●
25	Over Voltage Release			●	●
26	Under Frequency protection			●	●
27	Over Frequency protection			●	●
28	Voltage unbalance protection			●	●
29	Phase sequence protection			●	●
30	Over Temperature Protection			●	●
	Measurement Module			●	●
31	Current (Both in 3 phase & neutral)			●	●
32	Voltage (both Line & Phase)			●	●
33	Frequency			●	●
34	Temperature (°C)			●	●
35	Maximum Demand				●
36	Apparent Power (kVA)				●
37	Real Power (kW)				●
38	Reactive Power (kVAr)				●
39	Power factor				●
40	Communication Enabled (MODBUS)				●

\*Provided on request.

Communication software provided on request.

Note: IPR+ releases do not require any external power supply for their basic protection functioning. For other functions and display to run, they require an external power supply of 12 Vdc - 24 Vdc.

**Protection Release for Titania+  
(3200 A - 6300 A)**

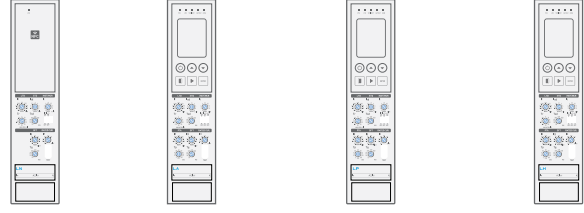

Model Name	N Type	A Type	P Type	H Type
	LN	LA	LP	LH
<b>Frequency</b>				
50 Hz	50 Hz	50 Hz	50 Hz	50 Hz
60 Hz	60 Hz	60 Hz	60 Hz	60 Hz
<b>Control Power</b>				
External Power	-	●	●	●
Self-Power	●	●	●	●
<b>Protection Function</b>				
LTD (Long Time)	●	●	●	●
STD (Short Time)	●	●	●	●
INST (Instantaneous)	●	●	●	●
Pre-Trip Alarm	-	●	●	●
Ground Fault Trip	●	●	●	●
Thermal Function	●	●	●	●
Field Test	-	●	●	●
Fail Safe	●	●	●	●
<b>Indication</b>				
True RMS Detection Method	●	●	●	●
LED Indication per Trip Type	-	●	●	●
Fault LED	L <sup>1)</sup>	PTA, L, S/I, G	PTA, L, S/I, G	PTA, L, S/I, G
Real-Time LCD Indication of Load Rate per Phase	-	●	●	●
Measurement LCD	-	●	●	●
3 Phase current	-	●	●	●
Voltage	-	-	●	●
Power	-	-	●	●
Power factor & power quantity	-	-	●	●
Demand	-	-	●	●
Zone selective interlocking	-	●	●	●
Voltage / current harmonics (1st ~ 63 th)	-	-	-	●
3 Phase wave form	-	-	-	●
TDH, TDD	-	-	-	●
<b>Output Contact</b>				
Integrated Instantaneous Contact (1a)	●	-	-	-
Individual Continuous Contact (4a)	-	●	●	●
<b>Operation</b>				
MCR	-	○	○	○
Communication	NFC	Modbus-RTU	Modbus-RTU	Modbus-RTU
Event/Fault Recording	●	●	●	●

● Standard ○: Option

1) Indicates reserve before operation during long time delay.

# Titania Air Circuit Breaker

(Conforms to IS/IEC:60947-2)

## Order Form

Please check  in front of appropriate box. Fill separate sheet for each type of ACB

CUSTOMER/ DEALER NAME	ORDER NO./DATE		END USER NAME				
Rating of ACB	630 A <input type="checkbox"/>	1000 A <input type="checkbox"/>	1600 A <input type="checkbox"/>	2500 A <input type="checkbox"/>	4000 A <input type="checkbox"/>	6300 A <input type="checkbox"/>	Qty.
	800 A <input type="checkbox"/>	1250 A <input type="checkbox"/>	2000 A <input type="checkbox"/>	3200 A <input type="checkbox"/>	5000 A <input type="checkbox"/>		
Breaking Capacity Icu	Upto 2500 A	50 kA <input type="checkbox"/>	65 kA <input type="checkbox"/>	75 kA <input type="checkbox"/>			
	3200 A to 6300 A		100 kA <input type="checkbox"/>	150 kA <input type="checkbox"/>			
No. of Poles		3 <input type="checkbox"/>	4 <input type="checkbox"/>	4 <input type="checkbox"/>			
			(100% Neutral)	(50% Neutral for V-Series only)			
Mounting	Fixed <input type="checkbox"/>	Drawout <input type="checkbox"/>	Standard (for E&S series) <input type="checkbox"/>		Vertical terminals (for H&V series) <input type="checkbox"/>		
	Note: For E & S series - Adapter terminals are on demand						
Spring Charging Operation	Manual <input type="checkbox"/>	Electrical <input type="checkbox"/>	Closing Coil _____ VAC / DC		Tripping Coil _____ VAC / DC		Motor _____ V
Release	Upto 2500 A	<input type="checkbox"/>	<input type="checkbox"/>	<input type="checkbox"/>	<input type="checkbox"/>	<input type="checkbox"/>	
		Without Release	IPR E +	IPR 1 +	IPR 3 +	IPR 5 +	
	3200 A to 6300 A	<input type="checkbox"/>	<input type="checkbox"/>	<input type="checkbox"/>	<input type="checkbox"/>	<input type="checkbox"/>	
		Without Release	LN	LA	LP	LH	
	Setting: O/L _____ A, S/C _____ A, Inst. _____ A, GFT _____ A, CT Rating _____ A, Neutral CT <input type="checkbox"/>						
	<b>Note:</b> Unless otherwise specified O/L will be set at maximum value and all other settings would be set at mid values.						
Other Accessories	Close open cycle counter	<input type="checkbox"/>	Five c/o additional Aux. contacts	<input type="checkbox"/>			
	Field test unit	<input type="checkbox"/>	Shunt Trip	<input type="checkbox"/>			
	Position Indication Switch	<input type="checkbox"/>	UVT	<input type="checkbox"/>			
	Spring Charge Indication Switch	<input type="checkbox"/>	Trip Indication Switch	<input type="checkbox"/>			
	Door Interlock	<input type="checkbox"/>	Key Interlock	1L+1K	<input type="checkbox"/>		
				2L+1K	<input type="checkbox"/>		
			3L+2K	<input type="checkbox"/>			

Note :

- Please specify the voltages for closing coil, shunt trip coil and UVT, available voltages are 24 VDC, 110 VAC / DC, 220 VAC / DC and 415 VAC and for motor available voltages are 220 VAC / DC and 110 VAC / DC.
- For details of Protection Releases, please refer the chart of technical features.

# Compact, Reliable & Robust

## HIM - Moulded Case Circuit Breakers



### Wide range of Circuit Breakers catering all kind of electrical applications

- HIM Series MCCBs upto 800 A are the natural selection for all kind of electrical distribution / applications.
- Double protective layer ensures high level of safety.
- High Electrical / Mechanical endurance for upgraded service life / dependability.
- All type of accessories for different frame provide greater control over distribution.
- Suitable for isolation.

### Advanced Breaking Performance and Various Selectivity

- Wide Product Range: 100 A - 800 A in 5 different frames.
- Thermal magnetic release with thermal adjustability in entire range.
- High breaking capacity with  $I_{cs} = 100\% I_{cu}$  from 16 kA to 85 kA.
- 2P, 3P and 4P versions available.
- Standardized Height of Products by Frame: 100 A - 250 A (68 mm), 400 A - 800 A (110 mm).

### Rated Short-Circuit Current by Ampere Frame, ( $I_{cs} = 100\% I_{cu}$ )

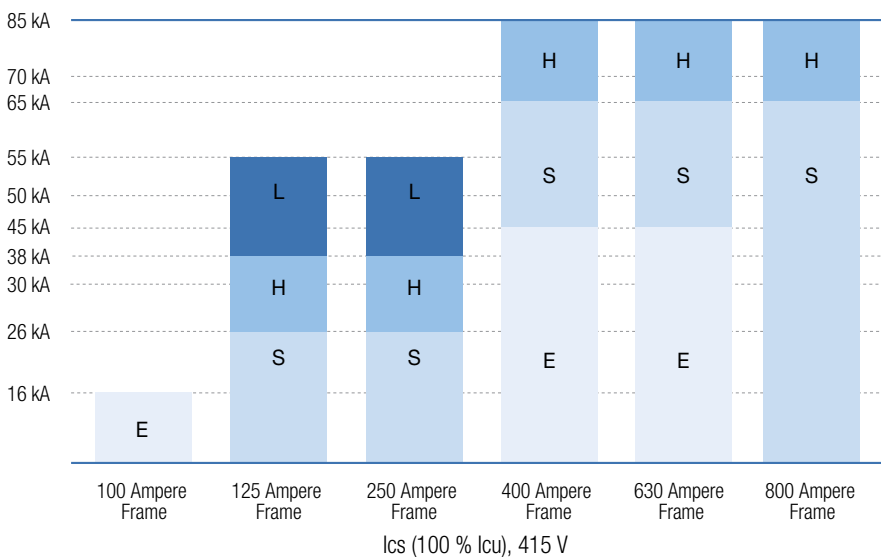

# Moulded Case Circuit Breakers

(Conforms to IS/IEC:60947-2)



## HIM MCCB

Conforms to IS/IEC60947-2

Ics=Icu=100%

16A to 800A

Up to 85kA breaking capacities

Adjustable Thermal & Fixed Magnetic



HSN Code: 85362020

Rated Ultimate Short-circuit Breaking Capacity Ics=100% Icu at 415 Vac (kA rms)	Rated Ultimate Short-circuit Breaking Capacity Icu at 250 V (2P in series)-DC (kA)	Current Rating (A)	Frame	Double Pole Cat. No.	Per Unit LP (₹)	Three Pole Cat. No.	Per Unit LP (₹)	Four Pole # Cat. No.	Per Unit LP (₹)	
16	5	16	HIM 100	IHDA3BBD0016	3630.00	IHDA3BBT0016	4995.00	IHDA3BBF0016	6415.00	
		20		IHDA3BBD0020		IHDA3BBT0020		IHDA3BBF0020		
		25		IHDA3BBD0025		IHDA3BBT0025		IHDA3BBF0025		
		32		IHDA3BBD0032		IHDA3BBT0032		IHDA3BBF0032		
		40		IHDA3BBD0040		IHDA3BBT0040		IHDA3BBF0040		
		50		IHDA3BBD0050		IHDA3BBT0050		IHDA3BBF0050		
		63		IHDA3BBD0063		IHDA3BBT0063		IHDA3BBF0063		
		80		IHDA3BBD0080		IHDA3BBT0080		IHDA3BBF0080		
		100		IHDA3BBD0100		IHDA3BBT0100		IHDA3BBF0100		
26	15	16	HIM 125	IHDA6OBD0016	5960.00	IHDA6OBT0016	8145.00	IHDA6OBF0016	11230.00	
		20		IHDA6OBD0020		IHDA6OBT0020		IHDA6OBF0020		
		25		IHDA6OBD0025		IHDA6OBT0025		IHDA6OBF0025		
		32		IHDA6OBD0032		IHDA6OBT0032		IHDA6OBF0032		
		40		IHDA6OBD0040		IHDA6OBT0040		IHDA6OBF0040		
		50		IHDA6OBD0050		IHDA6OBT0050		IHDA6OBF0050		
		63		IHDA6OBD0063		IHDA6OBT0063		IHDA6OBF0063		
		80		IHDA6OBD0080		IHDA6OBT0080		IHDA6OBF0080		
		100		IHDA6OBD0100		IHDA6OBT0100		IHDA6OBF0100		
		125	IHDA6OBD0125	IHDA6OBT0125	IHDA6OBF0125	13560.00				
		150	HIM 250		IHD2HOBT0150		IHD2HOBT0150	16230.00	IHD2HOBF0150	19290.00
		160			IHD2HOBT0160		IHD2HOBF0160			
		200			IHD2HOBT0200		IHD2HOBF0200		27450.00	
		225			IHD2HOBT0225		IHD2HOBF0225		31230.00	
		250			IHD2HOBT0250		IHD2HOBF0250			
38	20	16	HIM 125	IHDA6TBD0016	8215.00	IHDA6TBT0016	11310.00	IHDA6TBF0016	13990.00	
		20		IHDA6TBD0020		IHDA6TBT0020		IHDA6TBF0020		
		25		IHDA6TBD0025		IHDA6TBT0025		IHDA6TBF0025		
		32		IHDA6TBD0032		IHDA6TBT0032		IHDA6TBF0032		
		40		IHDA6TBD0040		IHDA6TBT0040		IHDA6TBF0040		
		50		IHDA6TBD0050		IHDA6TBT0050		IHDA6TBF0050		
		63		IHDA6TBD0063		IHDA6TBT0063		IHDA6TBF0063		
		80		IHDA6TBD0080		IHDA6TBT0080		IHDA6TBF0080		
		100		IHDA6TBD0100		IHDA6TBT0100		IHDA6TBF0100		
		125	IHDA6TBD0125	IHDA6TBT0125	IHDA6TBF0125	15710.00				
		150	HIM 250		IHD2HTBT0150		IHD2HTBT0150	19405.00	IHD2HTBF0150	22935.00
		160			IHD2HTBT0160		IHD2HTBF0160			
		200			IHD2HTBT0200		IHD2HTBF0200		27985.00	
		225			IHD2HTBT0225		IHD2HTBF0225		31030.00	
		250			IHD2HTBT0250		IHD2HTBF0250			
45	20	300	HIM 400	IHDA9UBT0300		IHDA9UBT0300	31750.00	IHDA9UBF0300	38350.00	
		350		IHDA9UBT0350		IHDA9UBF0350				
		400		IHDA9UBT0400		IHDA9UBF0400				
		500	HIM 630		IHD3HUBT0500		IHD3HUBT0500	45845.00	IHD3HUBF0500	55455.00
		630			IHD3HUBT0630		IHD3HUBF0630			

Note : Adjustable thermal (80% -100%) - In TP & FP upto HIM 250. #FP with Switched Neutral.  
 Adjustable thermal (63% -100%) - In TP & FP From HIM 400 to HIM 800.  
 2 nos for TP & 3 nos for FP phase separator is available in standard packaging alongwith MCCB.  
 MCCBs are without extended terminals, however extended terminals are available on request at extra price for these ratings

Effective from 11th March, 2024

List Price (LP) are in Indian ₹ & as per Standard Terms & Conditions **HAVELLS 56**



HSN Code: 85362020

Rated Ultimate Short-circuit Breaking Capacity Ics=100% Icu at 415 Vac (kA rms)	Rated Ultimate Short-circuit Breaking Capacity Icu at 250 V (2P in series)-DC (kA)	Current Rating (A)	Frame	Double Pole Cat. No.	Per Unit LP (₹)	Three Pole Cat. No.	Per Unit LP (₹)	Four Pole # Cat. No.	Per Unit LP (₹)
55	30	16	HIM 125	IHDA6VBD0016	10330.00	IHDA6VBT0016	14325.00	IHDA6VBF0016	17460.00
		20		IHDA6VBD0020		IHDA6VBT0020		IHDA6VBF0020	
		25		IHDA6VBD0025		IHDA6VBT0025		IHDA6VBF0025	
		32		IHDA6VBD0032		IHDA6VBT0032		IHDA6VBF0032	
		40		IHDA6VBD0040		IHDA6VBT0040		IHDA6VBF0040	
		50		IHDA6VBD0050		IHDA6VBT0050		IHDA6VBF0050	
		63		IHDA6VBD0063		IHDA6VBT0063		IHDA6VBF0063	
		80		IHDA6VBD0080		IHDA6VBT0080		IHDA6VBF0080	
		100		IHDA6VBD0100		IHDA6VBT0100		IHDA6VBF0100	
		125		IHDA6VBD0125		IHDA6VBT0125		IHDA6VBF0125	
		150	HIM 250	IHD2HVBT0150	24015.00	IHD2HVBF0150	28630.00		
		160		IHD2HVBT0160	IHD2HVBF0160				
		200		IHD2HVBT0200	24770.00	IHD2HVBF0200	31600.00		
		225		IHD2HVBT0225	IHD2HVBF0225				
250	IHD2HVBT0250	26790.00	IHD2HVBF0250	33685.00					
65	25	300	HIM 400	IHDA9LBT0300		IHDA9LBF0300	32235.00	IHDA9LBF0350	38140.00
		350		IHDA9LBT0350		IHDA9LBF0400			
		400		IHDA9LBT0400		IHDA9LBF0400			
		500	HIM 630	IHD3HLBT0500	46245.00	IHD3HLBF0500	56845.00		
		630	IHD3HLBT0630	IHD3HLBF0630					
		700	HIM 800	IHD4HLBT0700	52250.00	IHD4HLBF0700	67405.00		
800	IHD4HLBT0800	IHD4HLBF0800							
85	40	300	HIM 400	IHDA9MBT0300	39910.00	IHDA9MBF0300	45955.00	IHDA9MBF0350	45955.00
		350		IHDA9MBT0350		IHDA9MBF0400			
		400	HIM 630	IHDA9MBT0400	54320.00	IHDA9MBF0400	66785.00	IHD3HMBF0500	66785.00
		500		IHD3HMBT0500		IHD3HMBF0630			
		630	HIM 800	IHD3HMBT0630	62470.00	IHD3HMBF0630	80360.00	IHD4HMBF0700	80360.00
		700		IHD4HMBT0700		IHD4HMBF0800			
		800	IHD4HMBT0800	IHD4HMBF0800					

**Accessories for HIM Series Moulded Case Circuit Breakers** HSN Code: 85389000

Description	HIM 100 / 125 / 250 / Frame	HIM 400 / 630 / 800 Frame		
<b>Shunt Trip</b>				
24 Vdc	ISSLEU0800	1850.00		
48 Vdc	ISSLEU0801			
60 Vdc	ISSLEU0802			
100 Vdc -120 Vdc	ISSLEU1634			
125 Vdc	ISSLEU0803			
100 Vdc -125 Vdc		ISSLEU0907	2565.00	
100 Vac -120 Vac	ISSLEU0905	ISSLEU0908		
200 Vac -250 Vac	ISSLEU0906	ISSLEU0890		
380 Vac - 415 Vac	ISLEU0888	On Request		
<b>Under Voltage Release</b>				
24 Vdc	ISSLEU0804	2975.00	ISSLEU0912	3645.00
48 Vdc	ISSLEU0805			
100 Vdc - 110 Vdc	ISSLEU0909		ISSLEU0914	3645.00
100 Vac - 120 Vac	ISSLEU0910			
200 Vac - 230 Vac	ISSLEU0893			
380 Vac - 415 Vac	ISSLEU0894	ISSLEU0896		



SHT



UVT

Note : Adjustable thermal (80% -100%) - In TP & FP upto HIM 250. #FP with Switched Neutral.  
 Adjustable thermal (63% -100%) - In TP & FP From HIM 400 to HIM 800.  
 2 nos for TP & 3 nos for FP phase separator is available in standard packaging alongwith MCCB.  
 MCCBs are without extended terminals, however extended terminals are available on request at extra price for these ratings

# Moulded Case Circuit Breakers

(Conforms to IS/IEC:60947-2)

## Accessories for HIM Series Moulded Case Circuit Breakers

HSN Code: 85389000

Description	HIM 100 / 125 / 250 / Frame		HIM 400 / 630 / 800 Frame	
Auxiliary Contact (250 Vac / 250 Vdc) (450 Vac / 250 Vdc)				
1-Changeover	ISSLEU0791	990.00	ISSLEU0793	1090.00
2-Changeover	ISSLEU0792	1760.00		
Alarm Switch (Left side only)	ISSLEU0794	990.00	ISSLEU0796	1090.00
Alarm Switch (Right side only)	ISSLEU0795			
Auxiliary + Alarm Switch				
Left side only	ISSLEU0799	1710.00		
Right side only	ISSLEU0797			
Pad Lock Device	ISSLEU0844	1215.00	ISSLEU0845	1490.00
DIN Rail	ISSLEU0887	870.00		
Auxiliary Handle			ISSLEU0846	1490.00



HSN Code: 85389000

Description	HIM 100 Frame		HIM 125 Frame		HIM 250 Frame		HIM 400 Frame		HIM 630 / 800 Frame	
Rotary Handle										
Direct mounting	ISSLEU0806	1410.00	ISSLEU0809	1410.00	ISSLEU0812	1410.00	ISSLEU0815	2050.00	ISSLEU0916	3190.00
Door Mounting	ISSLEU0820	1870.00	ISSLEU0821	1980.00	ISSLEU0822	2170.00	ISSLEU0823	3365.00	ISSLEU0824	4165.00
Mechanical Interlock										
2 Pole	ISSLEU0825	1365.00	ISSLEU0829	1365.00						
3 Pole	ISSLEU0826	2545.00	ISSLEU0830	2545.00	ISSLEU0833	3085.00	ISSLEU0836	4940.00	ISSLEU0838	5730.00
4 Pole (N-R-S-T)	ISSLEU0828	3035.00	ISSLEU0832	3035.00	ISSLEU0835	3750.00	ISSLEU0837	5790.00	ISSLEU0843	6795.00
Motor Operator										
24 Vdc	ISSLEU0917		ISSLEU0897		ISSLEU0899		ISSLEU0901		ISSLEU0903	
110 Vac / Vdc	ISSLEU0918	31295.00	ISSLEU0920	31295.00	ISSLEU0921	31295.00	ISSLEU0922	44405.00	ISSLEU0923	49475.00
240 Vac / Vdc	ISSLEU0919		ISSLEU0898		ISSLEU0900		ISSLEU0902		ISSLEU0904	

HSN Code: 85389000

Description	HIM 100 Frame		HIM 125 Frame		HIM 250 Frame		HIM 400 Frame		HIM 630 Frame		HIM 800 Frame	
Spreader Terminals - Extended Type												
3 Pole (Set of 3)	ISSLEX1158	195.00	ISSLEX1160	250.00	ISSLEX1162	685.00	ISSLEX1164	1770.00	ISSLEX1168	1870.00	ISSLEX1166	3845.00
4 Pole (Set of 4)	ISSLEX1159	305.00	ISSLEX1161	360.00	ISSLEX1163	1050.00	ISSLEX1165	2310.00	ISSLEX1169	2505.00	ISSLEX1167	4730.00
Terminal Cover - Long Type												
2 Pole	ISSLEU0858	525.00	ISSLEU0864	525.00								
3 Pole	ISSLEU0859	790.00	ISSLEU0865	790.00	ISSLEU0869	1090.00	ISSLEU0873	2240.00	ISSLEU0877	2240.00		
4 Pole	ISSLEU0860	895.00	ISSLEU0866	895.00	ISSLEU0870	1275.00	ISSLEU0874	3130.00	ISSLEU0878	3130.00		
Phase Barrier												
2 Pole (Set of 1)	ISSLEU0924	65.00	ISSLEU0924	65.00	ISSLEU0882	85.00						
3 Pole (Set of 2)	ISSLEU0880	120.00	ISSLEU0880	120.00	ISSLEU0883	175.00	ISSLEU0885	695.00	ISSLEU0885	695.00	ISSLEU0885	695.00
4 Pole (Set of 3)	ISSLEU0881	185.00	ISSLEU0881	185.00	ISSLEU0884	250.00	ISSLEU0886	1040.00	ISSLEU0886	1040.00	ISSLEU0886	1040.00
Enclosure												
3 Pole	ISSBOU1189	1945.00	ISSBOU1191	2050.00	ISSBOU1193	2665.00	ISSBOU1195	9810.00	ISSBOU1197	10190.00	ISSBOU1199	10190.00
4 Pole	ISSBOU1190		ISSBOU1192		ISSBOU1194		ISSBOU1196		ISSBOU1198		ISSBOU1200	

HSN Code: 85371000

Description	HIM 100 Frame		HIM 125 Frame		HIM 250 Frame		HIM 400 Frame		HIM 630 Frame		HIM 800 Frame	
Enclosure												
3 Pole	ISSBOU1189	1945.00	ISSBOU1191	2050.00	ISSBOU1193	2665.00	ISSBOU1195	9810.00	ISSBOU1197	10190.00	ISSBOU1199	10190.00
4 Pole	ISSBOU1190		ISSBOU1192		ISSBOU1194		ISSBOU1196		ISSBOU1198		ISSBOU1200	

# The Compact Reliable Performer

## Loadline MCCB Range



- Current Rating: 15 A to 1600 A ● Execution: 1P, 2P, 3P & 4P ● Breaking Capacity: 10 kA to 50 kA
- Compact □ Thermal Magnetic & Microprocessor release □ Precise and reliable protection

# Loadline Moulded Case Circuit Breakers

(Conforms to IS/IEC:60947-2)

## MCCB Selection Chart - Loadline (TM / Microprocessor)

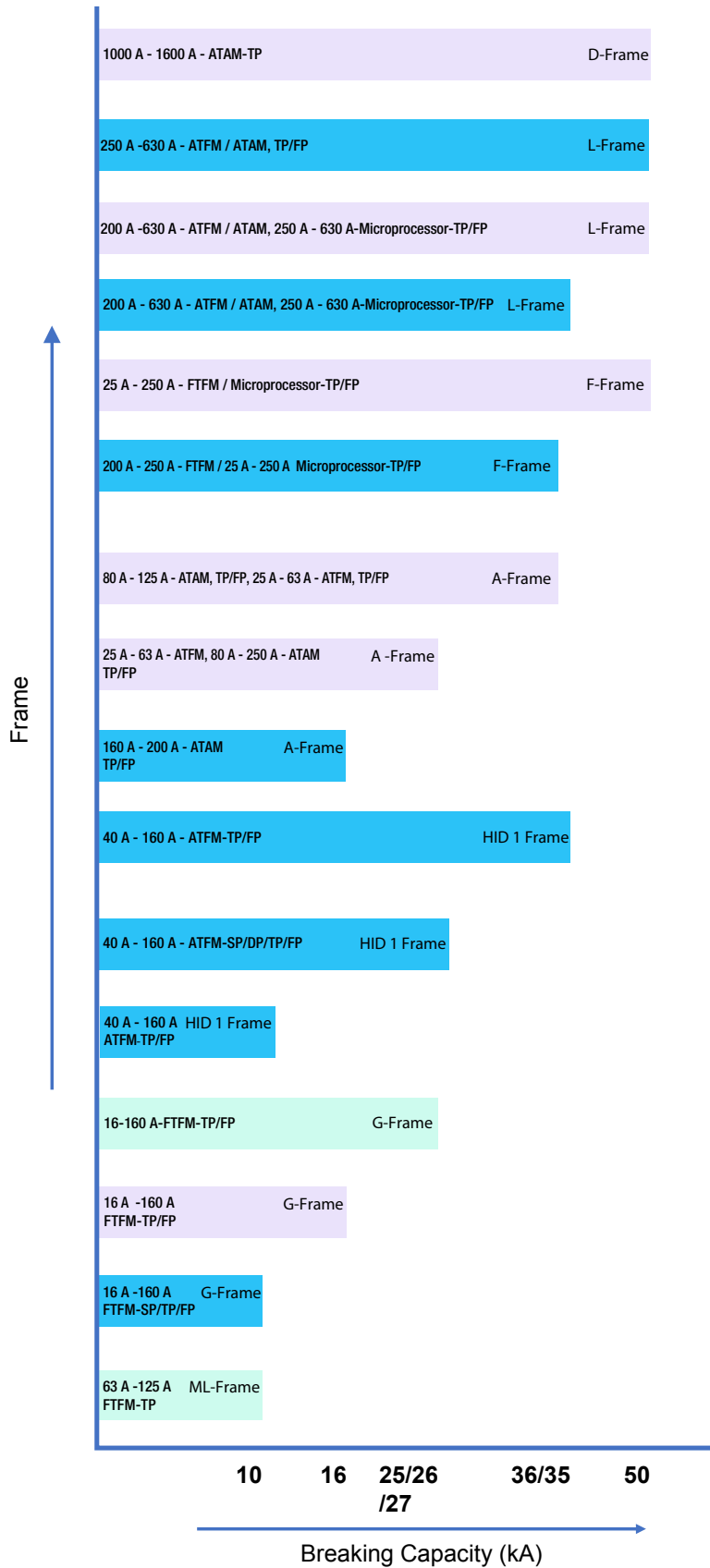

FTFM-Fixed Thermal and Fixed Magnetic  
 ATFM-Adjustable Thermal and Fixed Magnetic  
 ATAM-Adjustable Thermal and Adjustable Magnetic  
 Microprocessor based Trip Unit

Ics=100% Icu Ics=75% Icu Ics=50% Icu

# Loadline Moulded Case Circuit Breakers

(Conforms to IS/IEC:60947-2)

## Fixed Thermal & Fixed Magnetic

HSN Code: 85362020

Rated Ultimate Shortcircuit Breaking Capacity Icu at 415 V (kA rms)	Rated Service short circuit Breaking Capacity Ics = % Icu at 415 V (kA rms)	Current Rating (A)	Frame	Three Pole Cat. No.	Per Unit LP (₹)	Four Pole ## Cat. No.	Per Unit LP (₹)		
10	50%	15 A	SH	IHLSHAAT0015	POR				
		20 A		IHLSHAAT0020					
		32 A		IHLSHAAT0032					
		40 A		IHLSHAAT0040					
		63 A	ML1	IHLM1AAT0063	2070.00				
		80 A		IHLM1AAT0080#	2120.00				
		100 A		IHLM1AAT0100#	2215.00				
		125 A		IHLM1AAT0125#	2905.00				
	100%	25 A	GS	IHLGST0025	2345.00	IHLGSF0025	3060.00		
		32 A		IHLGST0032		IHLGSF0032			
		40 A		IHLGST0040		IHLGSF0040			
		50 A		IHLGST0050		IHLGSF0050			
		63 A		IHLGST0063		2345.00		IHLGSF0063	3090.00
		80 A		IHLGSAA30080		2345.00		IHLGSAA40080	3090.00
				IHLGST0080#		2440.00		IHLGSF0080#	3685.00
				IHLGS30100		2345.00		IHLGS40100	3090.00
				IHLGST0100#		2440.00		IHLGSF0100#	3685.00
				IHLGST0125#		3575.00		IHLGSF0125#	4230.00
	150 A	4610.00	IHLGST0150#	IHLGSF0150#	6105.00				
	160 A		IHLGST0160#	IHLGSF0160#					
16	75%	25 A	GN (Suitable for DC application 5 kA at 250 V DC, 2P in series)	IHLGNT0025	4575.00	IHLGNF0025	5400.00		
		32 A		IHLGNT0032		IHLGNF0032			
		40 A		IHLGNT0040		IHLGNF0040			
		50 A		IHLGNT0050		IHLGNF0050			
		63 A		IHLGNT0063		4575.00		IHLGNF0063	5400.00
		80 A		IHLGNT0080#		4665.00		IHLGNF0080#	5700.00
		100 A		IHLGNT0100#		5125.00		IHLGNF0100#	5955.00
		125 A		IHLGNT0125#				IHLGNF0125#	
		150 A		IHLGNT0150#		5985.00		IHLGNBAF0150#	6920.00
		160 A		IHLGNT0160#		IHLGNF0160#			
25	50%	25 A	GH	IHLGHT0025	5185.00	IHLGHF0025	6530.00		
		32 A		IHLGHT0032		IHLGHF0032			
		40 A		IHLGHT0040		IHLGHF0040			
		50 A		IHLGHT0050		IHLGHF0050			
		63 A		IHLGHT0063		5210.00		IHLGHF0063	6560.00
		80 A		IHLGHT0080#		5325.00		IHLGHF0080#	6560.00
		100 A		IHLGHT0100#		6195.00		IHLGHF0100#	8155.00
		125 A		IHLGHT0125#				IHLGHF0125#	
		150 A		IHLGHT0150#		8820.00		IHLGHF0150#	10290.00
		160 A		IHLGHT0160#		IHLGHF0160#			
35	100%	200 A	FN	IHLFN30200	21045.00	IHLFN40200	26360.00		
		250 A		IHLFN30250	23640.00	IHLFN40250	28820.00		
50	75%	25 A	FH	IHLFHT0025	12565.00	IHLFHF0025	13330.00		
		32 A		IHLFHT0032		IHLFHF0032			
		40 A		IHLFHT0040		IHLFHF0040			
		50 A		IHLFHT0050		IHLFHF0050			
		63 A		IHLFHT0063		IHLFHF0063			
		80 A		IHLFHFA30080		13425.00		IHLFHFA40080	14905.00
		100 A		IHLFH30100		15580.00		IHLFH40100	18660.00
		125 A		IHLFH30125				IHLFH40125	
		160 A		IHLFH30160		19325.00		IHLFH40160	22575.00
		200 A		IHLFH30200		22465.00		IHLFH40200	28340.00
250 A	IHLFH30250	24820.00	IHLFH40250	30930.00					

Phase barriers are supplied along with MCCBs  
 Spreader terminals are available as an accessories, refer page no. 66  
 # Both side terminal are included  
 ##FP with Switched Neutral.

# Loadline Moulded Case Circuit Breakers

(Conforms to IS/IEC:60947-2)

## Adjustable Thermal & Fixed Magnetic

HSN Code: 85362020

Rated Ultimate Shortcircuit Breaking Capacity Icu at 415 V (kA rms)	Rated Service short circuit Breaking Capacity Ics = % Icu at 415 V (kA rms)	Current Rating (A)	Frame	Three Pole Cat. No.	Per Unit LP (₹)	Four Pole ## Cat. No.	Per Unit LP (₹)
10	100%	40 A	HID 1	IHLE1ABT0040	4535.00	IHLE1ABF0040	5290.00
		50 A		IHLE1ABT0050		IHLE1ABF0050	
		63 A		IHLE1ABT0063		IHLE1ABF0063	
		80 A		IHLE1AB30080	4730.00	IHLE1AB40080	5485.00
		100 A		IHLE1AB30100		IHLE1AB40100	
		125 A		IHLE1AB30125		IHLE1AB40125	
		160 A		IHLE1AB30160		IHLE1AB40160	
25	75%	25 A	AS (Suitable for DC application 10 kA at 250 V DC, 2P in series)	IHLAST0025	7455.00	IHLASF0025	8795.00
		32 A		IHLAST0032		IHLASF0032	
		40 A		IHLAST0040		IHLASF0040	
		50 A		IHLAST0050		IHLASF0050	
		63 A		IHLAST0063		IHLASF0063	
27	100%	40 A	HID 1	IHA13DBT0040	7085.00	IHA13DBF0040	8250.00
		50 A		IHA13DBT0050		IHA13DBF0050	
		63 A		IHA13DBT0063		IHA13DBF0063	
		80 A		IHA13DB30080	8510.00	IHA13DB40080	10150.00
		100 A		IHA13DB30100		IHA13DB40100	
		125 A		IHA13DB30125		IHA13DB40125	
		160 A		IHA13DB30160		IHA13DB40160	
35	75%	25 A	AN	IHLANT0025	POR	IHLANF0025	POR
		32 A		IHLANT0032		IHLANF0032	
		40 A		IHLANT0040		IHLANF0040	
		50 A		IHLANT0050		IHLANF0050	
		63 A		IHLANT0063		IHLANF0063	
36	100%	40 A	HID 1	IHA13EBT0040	9830.00	IHA13EBF0040	11710.00
		50 A		IHA13EBT0050		IHA13EBF0050	
		63 A		IHA13EBT0063		IHA13EBF0063	
		80 A		IHA13EB30080	11255.00	IHA13EB40080	13275.00
		100 A		IHA13EB30100		IHA13EB40100	
		125 A		IHA13EB30125		IHA13EB40125	
		160 A	IHA13EB30160	11950.00	IHA13EB40160	13975.00	
		200 A	IHLLSEB30200	22130.00	IHLLSEB40200	26415.00	
		250 A	IHLLSEB30250	24830.00	IHLLSEB40250	29660.00	
		320 A	IHLLSEB30320	26700.00	IHLLSEB40320	32805.00	
		400 A	IHLLSEB30400		IHLLSEB40400		
		500 A	IHLLSEB30500		IHLLSEB40500		
		630 A	IHLLSEB30630	39130.00	IHLLSEB40630	48470.00	
50	75%	200 A	LN	IHLLNFB30200	24530.00	IHLLNFB40200	29040.00
		250 A		IHLLNFB30250	26535.00	IHLLNFB40250	31390.00
		320 A		IHLLNFB30320	28670.00	IHLLNFB40320	34690.00
		400 A		IHLLNFB30400		IHLLNFB40400	
		500 A		IHLLNFB30500	41795.00	IHLLNFB40500	51310.00
		630 A		IHLLNFB30630		IHLLNFB40630	



Adjustable thermal (70%-100%) in TP & FP for HID1 / A frame / D frame  
 Adjustable thermal (80%-100%) in TP & FP for L frame  
 Phase barriers are supplied along with MCCBs  
 Spreader terminals are available as an accessories, refer page no. 66  
 # Both side terminal are included  
 ##FP with Switched Neutral.

Effective from 11th March, 2024

List Price (LP) are in Indian ₹ & as per Standard Terms & Conditions **HAVELLS 62**

# Loadline Moulded Case Circuit Breakers

(Conforms to IS/IEC:60947-2)

## Adjustable Thermal & Adjustable Magnetic

HSN Code: 85362020

Rated Ultimate Shortcircuit Breaking Capacity Icu at 415 V (kA rms)	Rated Service short circuit Breaking Capacity Ics = % Icu at 415 V (kA rms)	Current Rating (A)	Frame	Three Pole Cat. No.	Per Unit LP (₹)	Four Pole ## Cat. No.	Per Unit LP (₹)	
16	100%	160 A	AS	IHLASBC30160	8465.00	IHLASBC40160	11625.00	
		200 A		IHLASBC30200	10030.00	IHLASBC40200	12695.00	
25	75%	80 A	AS (Suitable for DC application 10 kA at 250 V DC 2P in series)	IHLASDC30080	7585.00	IHLASDC40080	9180.00	
		100 A		IHLASDC30100		IHLASDC40100		
		125 A		IHLASDC30125		IHLASDC40125		
		160 A	AN (Suitable for DC application 10 kA at 250 V DC 2P in series)	IHLANDC30160	10415.00	IHLANDC40160	12465.00	
		200 A		IHLANDC30200	10560.00	IHLANDC40200	12990.00	
		250 A		IHLANDC30250	11400.00	IHLANDC40250	14410.00	
35	75%	80 A	AN	IHLANEC30080	10370.00	IHLANEC40080	12365.00	
		100 A		IHLANEC30100		IHLANEC40100		
		125 A		IHLANEC30125		IHLANEC40125		
36	100%	200 A	LS	IHLSEC30200	23115.00	IHLSEC40200	27115.00	
		250 A		IHLSEC30250		IHLSEC40250		
		320 A		IHLSEC30320		IHLSEC40320		
		400 A		IHLSEC30400		IHLSEC40400		
		500 A		39880.00		IHLSEC40500		49490.00
		630 A				IHLSEC30630		
50	75%	200 A	LN	IHLNFC30200	27545.00	IHLNFC40200	32440.00	
		250 A		IHLNFC30250		IHLNFC40250		
		320 A		IHLNFC30320		IHLNFC40320		
		400 A		IHLNFC30400		IHLNFC40400		
		500 A		43090.00		IHLNFC40500		52730.00
		630 A				IHLNFC30630		
	100%	250 A	L	IHLLSFC30250	30385.00	IHLLSFC40250	36155.00	
		320 A		IHLLSFC30320		IHLLSFC40320		
		400 A		IHLLSFC30400		IHLLSFC40400		
		500 A		44625.00		IHLLSFC40500		53340.00
		630 A				IHLLSFC30630		
		75%		1000 A		DN		IHLDNT1000
	1250 A		IHLDNT1250	173000.00				
	1600 A		IHLDNT1600	186460.00				

## Single Pole And Double Pole MCCB

HSN Code: 85362020

Rated Ultimate Shortcircuit Breaking Capacity Icu at 240 V AC (kA rms)	Rated Service short circuit Breaking Capacity Ics = % Icu at 240 V AC (kA rms)	Current Rating (A)	Frame	Single Pole Cat. No.	Per Unit LP (₹)	Rated Ultimate Shortcircuit Breaking Capacity Icu at 240 V AC (kA rms)	Rated Service short circuit Breaking Capacity Ics = % Icu at 240 V AC (kA rms)	Double Pole Cat. No.	Per Unit LP (₹)	
10	100%	25 A	GS	IHLGSS0025	1080.00	36	100%			
		32 A		IHLGSS0032						
		40 A		IHLGSS0040						
		50 A		IHLGSS0050						
		63 A		IHLGSS0063	1080.00					
		80 A		IHLGSS0080#						
		100 A		IHLGSS0100#	1290.00					
		125 A		IHLGSS0125#						
		150 A		IHLGSS0150#	1390.00					
		160 A		IHLGSS0160#						
27	100%	40 A	HID 1	IHA13DBS0040	3725.00	36	100%	IHA13DBD0040	5445.00	
		50 A		IHA13DBS0050				IHA13DBD0050		
		63 A		IHA13DBS0063				IHA13DBD0063		
		80 A		IHA13DB10080				IHA13DB20080		
		100 A		IHA13DB10100				IHA13DB20100		
		125 A		IHA13DB10125				IHA13DB20125		6550.00
		160 A		IHA13DB10160				IHA13DB20160		7465.00

Adjustable thermal (70%-100%) in TP & FP for HID1 / A frame / D frame

Adjustable thermal (80%-100%) in TP & FP for L frame

Please refer catalogue for magnetic adjustability details

Phase barriers are supplied along with MCCBs

Spreader terminals are available as an accessories, refer page no. 66

# Both side terminal are included

##FP with Switched Neutral

# Loadline Moulded Case Circuit Breakers

(Conforms to IS/IEC:60947-2)

## Microprocessor MCCB

Adjustable Overload, Short-circuit, Ground fault (4 Pole) & Fixed Instantaneous  
Neutral Protection (4 Pole)

HSN Code: 85362020

Rated Ultimate Shortcircuit Breaking Capacity Icu at 415 V (kA rms)	Rated Service short circuit Breaking Capacity Ics = % Icu at 415 V (kA rms)	Current Rating (A)	Frame	Three Pole Cat. No.	Per Unit LP (₹)	Four Pole ## Cat. No.	Per Unit LP (₹)		
35	100%	25 A	FEN	IHLFENT0025	16310.00	IHLFENF0025	21115.00		
		32 A		IHLFENT0032		IHLFENF0032			
		40 A		IHLFENT0040		IHLFENF0040			
		50 A		IHLFENT0050		IHLFENF0050			
		63 A		IHLFENT0063		IHLFENF0063			
		80 A		IHLFEN30080		IHLFEN40080			
		100 A		IHLFEN30100		IHLFEN40100			
		125 A		IHLFEN30125		IHLFEN40125			
		160 A		IHLFEN30160		IHLFEN40160		20645.00	26085.00
		200 A		IHLFEN30200		IHLFEN40200		28495.00	33535.00
		250 A		IHLFEN30250		IHLFEN40250			
36	100%	250 A	LES	IHLLSEE30250	38095.00	IHLLSEE40250	46110.00		
		320 A		IHLLSEE30320		IHLLSEE40320			
		400 A		IHLLSEE30400		IHLLSEE40400			
		500 A		IHLLSEE30500		IHLLSEE40500		42665.00	56960.00
		630 A		IHLLSEE30630		IHLLSEE40630			
50	75%	25 A	FEH	IHLFEHT0025	19435.00	IHLFEHF0025	24895.00		
		32 A		IHLFEHT0032		IHLFEHF0032			
		40 A		IHLFEHT0040		IHLFEHF0040			
		50 A		IHLFEHT0050		IHLFEHF0050			
		63 A		IHLFEHT0063		IHLFEHF0063			
		80 A		IHLFEH30080		IHLFEH40080			
		100 A		IHLFEH30100		IHLFEH40100			
		125 A		IHLFEH30125		IHLFEH40125			
		160 A		IHLFEH30160		IHLFEH40160		25430.00	31465.00
		200 A		IHLFEH30200		IHLFEH40200		32600.00	37875.00
		250 A		IHLFEH30250		IHLFEH40250			
		250 A	LEN	IHLLNFE30250	IHLLNFE40250	41505.00	51975.00		
		320 A		IHLLNFE30320	IHLLNFE40320				
		400 A		IHLLNFE30400	IHLLNFE40400				
		500 A		IHLLNFE30500	IHLLNFE40500			44360.00	58180.00
		630 A		IHLLNFE30630	IHLLNFE40630				

Phase barriers are supplied along with MCCBs  
 Spreader terminals are available as an accessories, refer page no. 66  
 Only one internal accessories can be fitted in microprocessor MCCB  
 # Both side terminal are included  
 ##FP with Switched Neutral  
 For Communication enabled MCCB please contact with nearest branch



# Loadline Moulded Case Circuit Breakers

(Conforms to IS/IEC:60947-2)

## Spreader Terminal kit (1 side)

HSN Code: 85389000

Frame Size	RATING	POLE	FG CODES	Per Unit LP (₹)
GS, GN, GH	80 A - 100 A	1P	ISSLGX0153	70.00
		3P	ISSLGX0154	195.00
		4P	ISSLGX0155	305.00
	125 A	1P	ISSLGX0156	85.00
		3P	ISSLGX0157	250.00
		4P	ISSLGX0158	360.00
	160 A	1P	ISSLGX0159	110.00
		3P	ISSLGX0160	335.00
		4P	ISSLGX0161	445.00
AS, AN, AH	80 A~100 A	3P	ISSLAX0121	290.00
		4P	ISSLAX0122	400.00
	125 A~200 A	3P	ISSLAX0124	425.00
		4P	ISSLAX0125	580.00
	250 A	3P	ISSLAX0127	725.00
		4P	ISSLAX0128	1050.00
LS, LN	200 A~400 A	3P	ISSLLX0065	1770.00
		4P	ISSLLX0066	2310.00
	500 A~630 A	3P	ISSLLX0067	1870.00
		4P	ISSLLX0068	2505.00
FN, FH	80 A~100 A	3P	ISSLFX0074	290.00
		4P	ISSLFX0075	400.00
	125 A~160 A	3P	ISSLFX0076	425.00
		4P	ISSLFX0077	580.00
	200 A~250 A	3P	ISSLFX0078	725.00
		4P	ISSLFX0079	1050.00
HID 1	80 A~100 A	1P	ISSLHX4273	85.00
	125 A~160 A	1P	ISSLHX4274	110.00
	80 A~100 A	2P	ISSLHX4275	170.00
	125 A~160 A	2P	ISSLHX4276	220.00
	80 A~100 A	3P	ISSLHX4277	250.00
	125 A~160 A	3P	ISSLHX4278	335.00
	80 A~100 A	4P	ISSLHX4279	360.00
	125 A~160 A	4P	ISSLHX4280	480.00

## Enclosures for MCCBs

HSN Code: 85371000

Sl.No.	Description	Item Code	Per Unit LP (₹)
1.	'ML' Frame TP	IHEMTP	2155.00
2.	'G' Frame TP	IHEGTP	
3.	'G' Frame FP	IHEGFP	
4.	'A' Frame TP	IHEATP	2475.00
5.	'A' Frame FP	IHEAFP	
6.	'F' Frame TP	IHEFTP	2605.00
7.	'F' Frame FP	IHEFFP	
8.	'L' Frame TP	IHELTP	9785.00
9.	'L' Frame FP	IHELFP	
10.	HID 1 Frame TP	ISSBOU1117	2320.00
11.	HID 1 Frame FP	ISSBOU1118	



# Loadline Moulded Case Circuit Breakers

(Conforms to IS/IEC:60947-2)

## Loadline Moulded Case Circuit Breakers Accessories

HSN Code: 85389000

Description	'G' / 'ML' Frame		'A' Frame		HID 1 Frame		'L' Frame		'F' Frame	
	Item Code	Per Unit LP (₹)	Item Code	Per Unit LP (₹)	Item Code	Per Unit LP (₹)	Item Code	Per Unit LP (₹)	Item Code	Per Unit LP (₹)
<b>Shunt Trip</b>										
100 Vac - 110 Vac	IHLGS110		IHLAS110		ISSLEU0438		IHLLS110		IHLLSTF110	
220 Vac - 240 Vac	IHLGS240	1225.00	IHLAS240	1785.00	ISSLEU0439	1785.00	IHLLS240	2500.00	IHLLSTF240	1785.00
380 Vac - 415 Vac	IHLGS415		IHLAS415		ISSLEU0440		IHLLS415		IHLLSTF415	
<b>Under Voltage Release</b>										
110 Vac - 120 Vac	IHLGU110		IHLAU110		-	-	IHLLU110		IHLVRF110	
220 Vac - 240Vac	IHLGU240	1855.00	IHLAU240	2740.00	-	-	IHLLU240	3405.00	IHLVRF240	2740.00
380 Vac - 440 Vac	IHLGU440		IHLAU440		-	-	IHLLU415		IHLVRF440	
<b>Auxiliary Contact (250Vac/250Vdc) (450Vac/250Vdc)</b>										
1-Changeover	IHLASG1CO	830.00	IHLAA1CO	910.00	ISSLEU0444	910.00	IHLA1CO	1050.00	IHLASF1CO	990.00
2-Changeover	IHLASG2CO	1325.00	IHLAA2CO	1515.00	ISSLEU0445	1515.00	IHLA2CO	1820.00	IHLASF2CO	1515.00
<b>Rotary Handle</b>										
Direct mounting	IHLGD000	1255.00	IHLAD000	1655.00						
Door Mounting	IHLGRN30	1565.00	IHLARN30	2155.00	ISSLEU0494	1895.00	IHLLRN30	3185.00	IHLRRHF30	2155.00
<b>Padl Lock Device</b>										
	IHLDPG125	125.00	IHLDPA250	190.00	ISSLEU0448	375.00	IHLPP000	435.00	IHLDPF250	265.00
Trip Alarm Contact (Factory Fitted)	IHLALG1CO	830.00	IHLALA1CO	910.00	ISSLEU0447	910.00	IHLB000	1050.00	IHLALF1CO	990.00
<b>Auxiliary Contact + Alram Switch (Factory fitted)</b>										
							ISSLEU1772	1820.00		

## Earth Fault Relay for MCCBs

HSN Code: 85389000

Sl. No.	MCCBs Current Range (A)	Item Code**	Per Unit LP (₹)
1	25 A- 100 A	IHEF1100	7675.00
2	125 A- 200 A	IHEF2200	8710.00
3	250 A- 400 A	IHEF3400	10165.00
4	500 A- 800 A	IHEF4800	12675.00



- The above prices are inclusive of CBCT.

\*\* For operating the Earth Fault Relay a Shunt trip or an UVR has to be used.

Note : For operating Shunt Trip for G Frame, a separate auxiliary switch would be required in which case one c/o. will be used with the shunt trip, leaving one c/o. free for use. Door mounting clamps for G & AA Frame are supplied free of cost on request basis.

**‘G’ Frame Panel Boards, O/G TP MCCBs G-Frame**

HSN Code: 85371000

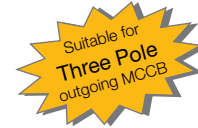

Incomer**	Outgoing* (No. of Ways)	Single Door Item Code	Per Unit LP (₹)	Double Door Item Code	Per Unit LP (₹)
250 A "AA" Frame MCCB	2	IHVG025002	41245.00	IHVG02500200	45060.00
	4	IHVG025004	51815.00	IHVG02500400	55580.00
	6	IHVG025006	59300.00	IHVG02500600	63090.00
	8	IHVG025008	64210.00	IHVG02500800	68000.00
	12	IHVG025012	79290.00	IHVG02501200	83020.00
	16	IHVG025016	93290.00	IHVG02501600	97080.00
400 A "LS" Frame MCCB	2	IHLG040002	48180.00	IHLG04000200	52650.00
	4	IHLG040004	57535.00	IHLG04000400	61720.00
	6	IHLG040006	61245.00	IHLG04000600	65165.00
	8	IHLG040008	65425.00	IHLG04000800	69290.00
	12	IHLG040012	84280.00	IHLG04001200	88230.00
	16	IHLG040016	100080.00	IHLG04001600	104155.00

Single door



\* The outgoings number of ways is the number of "G" Frame TP MCCBs that can be mounted. In case of SP MCCBs the number of MCCBs shall be three times the number of ways in TP MCCBs.

\*\* Maximum ratings are indicated for the incoming MCCBs however lower ratings in the same frame can be ordered. The above prices are for bare enclosures only, incoming and outgoing MCCBs have to be ordered separately.

**‘G’ Frame Panel Boards, O/G FP MCCBs G-Frame**

HSN Code: 85371000

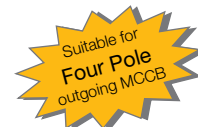

Incomer**	Outgoing* (No. of Ways)	Single Door Item Code	Per Unit LP (₹)	Double Door Item Code	Per Unit LP (₹)
250 A "AA" Frame MCCB	2	IHVGF25002	44395.00	IHVGF2500200	48130.00
	4	IHVGF25004	55215.00	IHVGF2500400	58990.00
	6	IHVGF25006	65015.00	IHVGF2500600	68745.00
	8	IHVGF25008	70165.00	IHVGF2500800	73940.00
	12	IHVGF25012	101785.00	IHVGF2501200	105550.00
400 A "LS" Frame MCCB	2	IHLGF40002	51860.00	IHLGF4000200	56235.00
	4	IHLGF40004	61315.00	IHLGF4000400	65490.00
	6	IHLGF40006	67140.00	IHLGF4000600	71000.00
	8	IHLGF40008	71490.00	IHLGF4000800	75350.00
	12	IHLGF40012	108175.00	IHLGF4001200	112180.00

\* The outgoings number of ways is the number of "G" Frame FP MCCBs that can be mounted. In case of SP MCCBs the number of MCCBs shall be four times the number of way in FP O/G MCCBs.

\*\* Maximum ratings are indicated for the incoming MCCBs however lower ratings in the same frame can be ordered. Outgoing spreader link for MCCB are available on request. The above prices are for bare enclosures only, incoming and outgoing MCCBs have to be ordered separately.

**Accessories : Cable Alley for 'G' / 'A' Frame Panel Boards - Outgoing TP MCCB,**

Incomer 'A' & 'L' Frame MCCB

HSN Code: 85389000

Sl. No.	Description*	Single Door Item Code	Per Unit LP (₹)	Double Door Item Code	Per Unit LP (₹)
1	Cable Alley I/C 250 A,O/G 3P GF 2/4Way	ISSBOU0674	15995.00	ISSBOU0690	17150.00
2	Cable Alley I/C 250 A,O/G 3P GF 6WAY & 4P 2/4Way	ISSBOU0675	21475.00	ISSBOU0691	22640.00
3	Cable Alley I/C 250 A,O/G 3P GF 8WAY & 4P 6Way	ISSBOU0676	21770.00	ISSBOU0692	23745.00
4	Cable Alley I/C 250 A,O/G 3P GF 12Way	ISSBOU0677	24695.00	ISSBOU0693	25380.00
5	Cable Alley I/C 250 A,O/G 4P GF 8Way	ISSBOU0678	24695.00	ISSBOU0694	25380.00
6	Cable Alley I/C 250 A,O/G 3P GF 16Way & 4P 12Way	ISSBOU0679	29090.00	ISSBOU0696	30190.00
7	Cable Alley I/C 400 A,O/G 3P GF 2/4Way	ISSBOU0680	18935.00	ISSBOU0697	19620.00
8	Cable Alley I/C 400 A,O/G 3P GF 6WAY & 4P 2/4Way	ISSBOU0681	18935.00	ISSBOU0698	19620.00
9	Cable Alley I/C 400 A/630 A, O/G 3P GF 8Way, 4P 6Way & A/F 6Way	ISSBOU0682	25460.00	ISSBOU0699	26695.00
10	Cable Alley I/C 400 A,O/G 3P GF 12Way	ISSBOU0683	29380.00	ISSBOU0700	30190.00
11	Cable Alley I/C 400 A/630 A, O/G 4P GF 8Way & TP A/F 8Way	ISSBOU0684	30880.00	ISSBOU0701	31560.00
12	Cable Alley I/C 400 A/630, O/G 4P GF 12Way, TP GF 16Way & TP A/F 12Way	ISSBOU0685	32250.00	ISSBOU0702	32935.00

\* Each set of Cable Alley consists of two numbers, one each on LHS and RHS.

**'A' Frame Panel Boards, O/G TP MCCBs**

HSN Code: 85371000

Incomer**	Outgoing* (No. of Ways)	Single Door Item Code	Per Unit LP (₹)	Double Door Item Code	Per Unit LP (₹)
400 A "LS" Frame MCCB	6	IHLA040006	83090.00	IHLA04000600	86115.00
	8	IHLA040008	88755.00	IHLA04000800	91860.00
	12	IHLA040012	114320.00	IHLA04001200	117285.00
630 A "L" Frame MCCB	6	IHLA063006	91340.00	IHLA06300600	96370.00
	8	IHLA063008	97340.00	IHLA06300800	100955.00
	12	IHLA063012	115650.00	IHLA06301200	130520.00

Double door



\* The outgoings number of ways is the number of "A" Frame TP MCCBs that can be mounted.

\*\* Maximum ratings are indicated for the incoming MCCBs however lower ratings in the same frame can be ordered.

Outgoing spreader link for MCCB are available on request.

The above prices are for bare enclosures only, incoming and outgoing MCCBs have to be ordered separately.

**Terminal for G & A Frame Outgoing**

HSN Code: 85389000

S. No.	Description	Item Code	Per Unit LP (₹)
1	Terminal for G Frame Outgoing (Per Pole)	ISCCUPBOP151	115.00
2	Terminal for A Frame Outgoing (Per Pole)	ISCCUPBOP167	295.00

**Pre-Wired Meter Module with Voltmeter, Ammeter, Selector Switch, Ct's Control Fuse & Indicating Lights**

HSN Code: 85389000

S. No.	Description	Single Door Item Code	Per Unit LP (₹)	Double Door Item Code	Per Unit LP (₹)
1	Prewire Meter Module - Analog	ISSBOU0689	18525.00	ISSBOU0706	19225.00
2	Meter Module - Digital	ISSBOU0711	22780.00	ISSBOU0707	24020.00

## Bare Meter Module / MCB Module / Add on Module

HSN Code: 85389000

S. No.	Description	Single Door Item Code	Per Unit LP (₹)	Double Door Item Code	Per Unit LP (₹)
1	Meter Module - Analog Provision for Ammeter, Voltmeter - Analog with selector switch	ISSBOU0686	7135.00	ISSBOU0703	8230.00
2	MCB Module	ISSBOU0687	7135.00	ISSBOU0704	
3	Add on Module	ISSBOU0688	7135.00	ISSBOU0705	

Ammeter, Voltmeter, Selector Switch, Control Fuses, Indicating Lights, MCBs etc. have to be ordered separately and are at extra cost. The above prices are for bare module enclosures only.

## Add on Incoming Changeover Switch Enclosure only\*\*

HSN Code: 85389000

S. No.	Description	Item Code	Per Unit LP (₹)
1	250 A Incoming change Over switch-F1	ISSBOU0708	13550.00
2	400 A & 630 A Incoming change Over switch - F2	ISSBOU0709	19915.00

\*\* The above prices are for bare module enclosures only.

## Add on Incoming Changeover Switch with Enclosure

HSN Code: 85389000

S. No.	Description	Item Code	Per Unit LP (₹)
1	250 A Incoming change Over switch-F1	ISSBOU0712	53955.00
2	400 A Incoming change Over switch - F2	ISSBOU0713	71500.00
3	630 A Incoming change Over switch - F3	ISSBOU0714	79950.00

## Add on Incoming Automatic Changeover Switch with Enclosure

HSN Code: 85371000

S. No.	Description	Item Code	Per Unit LP (₹)
1	100 A ATS FITT. ENCL P.SAFE	ISSBOU1128	143195.00
2	125 A ATS FITT. ENCL P.SAFE	ISSBOU1129	149895.00
3	250 A ATS FITT. ENCL P.SAFE	ISSBOU1126	208635.00



## Busbar Chambers - (Wall Mounted)

Busbar made of ETP Grade Copper

HSN Code: 85369030

Current Rating (A)	No. of	Item Code	Per Unit LP (₹)
63 A	4 WAY	IHBC006304	9675.00
	6 WAY	IHBC006306	11285.00
	8 WAY	IHBC006308	12995.00
100 A	4 WAY	IHBC010004	11610.00
	6 WAY	IHBC010006	16080.00
	8 WAY	IHBC010008	16895.00
200 A	4 WAY	IHBC020004	14525.00
	6 WAY	IHBC020006	18805.00
	8 WAY	IHBC020008	20520.00
250 A	4 WAY	IHBC025004	24045.00
	6 WAY	IHBC025006	37840.00
	8 WAY	IHBC025008	47325.00
315 A	4 WAY	IHBC031504	25120.00
	6 WAY	IHBC031506	38935.00
	8 WAY	IHBC031508	49750.00
400 A	4 WAY	IHBC040004	27140.00
	6 WAY	IHBC040006	40945.00
	8 WAY	IHBC040008	51490.00
630 A	4 WAY	IHBC063004	41570.00
	6 WAY	IHBC063006	55145.00
	8 WAY	IHBC063008	66335.00
800 A	4 WAY	IHBC080004	44220.00
	6 WAY	IHBC080006	58930.00





HSN Code: 85365090

Open Enclosure			
Frame	Rating (A)	Catalogue Code	Per Unit LP (₹)
IS00	40	IHCCFO0040	5625.00
	63	IHCCFO0063	5910.00
	100	IHCCFO0100	7920.00
	125*	IHCPFO0125	10115.00
IS02	125	IHCCFO0125	11835.00
	160	IHCCFO0160	12680.00
	200	IHCCFO0200	15205.00
	250*	IHCPFO0250	16725.00
IS04	250	IHCCFO0250	22000.00
	315	IHCCFO0315	23240.00
	400*	IHCPFO0400	25570.00
IS06	400	IHCCFO0400	33585.00
	630	IHCCFO0630	39905.00
	800*	IHCPFO0800	45890.00

SS Enclosure Version			
Frame	Rating (A)	Catalogue Code	Per Unit LP (₹)
IS00	40	IHCCFE0040	9405.00
	63	IHCCFE0063	9690.00
	100	IHCCFE0100	11700.00
	125*	IHCPFE0125	13895.00
IS02	125	IHCCFE0125	17135.00
	160	IHCCFE0160	17980.00
	200	IHCCFE0200	20505.00
	250*	IHCPFE0250	22030.00
IS04	250	IHCCFE0250	28510.00
	315	IHCCFE0315	29750.00
	400*	IHCPFE0400	32080.00
IS06	400	IHCCFE0400	44610.00
	630	IHCCFE0630	50930.00
	800*	IHCPFE0800	56915.00

\*Compact Design

**Accessories**



Castell Lock



Auxiliary Switch



Direct Handle Conversion Kit

HSN Code: 85389000

Code	Item Description	Per Unit LP (₹)
ISSCNX0218	Castell Lock Frame IS00	2795.00
ISSCNX0217	Castell Lock Frame IS02 / IS04 / IS06	2795.00
ISCELQOX0074	Auxiliary Switch Assembly 2NO 2NC Frame IS00	685.00
ISCELQOX0076	Auxiliary Switch Assembly 2NO 2NC Frame IS02, IS04 & IS06	895.00
ISSCNX0235	Direct Handle IS00	550.00
ISSCNX0221	Direct Handle IS02-IS04-IS06	1605.00



HSN Code: 85371000

Open Enclosure			
Frame	Rating (A)	Catalogue Code	Per Unit LP (₹)
IS02	125	IHLFNAO125	45435.00
	160	IHLFNAO160	46280.00
	200	IHLFNAO200	48805.00
	250*	IHLFNAO25D	50325.00
IS04	250	IHLFNAO250	66100.00
	315	IHLFNAO315	67340.00
	400*	IHLFNAO40D	69670.00
IS06	400	IHLFNAO400	83985.00
	630	IHLFNAO630	90305.00
	800*	IHLFNAO80D	96290.00

SS Enclosure Version			
Frame	Rating (A)	Catalogue Code	Per Unit LP (₹)
IS02	125	IHLFNAE125	53275.00
	160	IHLFNAE160	54120.00
	200	IHLFNAE200	56650.00
	250*	IHLFNAE25D	58170.00
IS04	250	IHLFNAE250	75050.00
	315	IHLFNAE315	76295.00
	400*	IHLFNAE40D	78620.00
IS06	400	IHLFNAE400	98025.00
	630	IHLFNAE630	104345.00
	800*	IHLFNAE80D	110330.00

\*Compact Design

## Accessories



**MTSE to RTSE  
Conversion Kit**



**RTSE Enclosure  
(with IP 32)**



**RTSE Enclosure  
(with IP 43)\***

HSN Code: 85389000

Item Description	Code	Item Description	Per Unit LP (₹)
MTSE to RTSE Conversion Kit	ISSCNX0211	MOTOR MODULE 125A-400A CD	POR
	ISSCNX0212	MOTOR MODULE 400A-800 A CD	
RTSE Enclosure (with IP 32)	ISSCNX0204	Enclosure Frame IS02	POR
	ISSCNX0205	Enclosure Frame IS04	
	ISSCNX0206	Enclosure Frame IS06	
RTSE Enclosure (with IP 43)	ISSCNX0256	Enclosure Frame IS02	POR
	ISSCNX0257	Enclosure Frame IS04	
	ISSCNX0258	Enclosure Frame IS06	

\*Available on request

## Insta<sup>prime</sup> Automatic Transfer Switch

Four Pole, AC-32B / AC - 33B\*, 50 Hz, 415 V  
Automatic/Manual Range

HSN Code: 85371000

Rating (A)	Open Execution Item Code	Per Unit LP (₹)	Cat. no. 4 pole (Close Execution)	Per Unit LP (₹)
40 A	IHRFBAO040	25345.00	IHRFBAE040	27470.00
63 A	IHRFBAO063	26495.00	IHRFBAE063	28625.00
80 A	IHRFBAO080	27810.00	IHRFBAE080	29930.00
100 A	IHRFBAO100	28750.00	IHRFBAE100	30875.00
125 A	IHRFBAO125	32565.00	IHRFBAE125	34685.00



\* Up to 80 A

## Insta<sup>line</sup> Automatic Transfer Switch

Four Pole, AC-31A, 50 Hz, 415 V  
Automatic/Manual with complete protection

HSN Code: 85371000

Rating A	Item Code 4P	Per Unit LP (₹)	Item Code 4P	Per Unit LP (₹)
	Open Execution		With Enclosure	
100 A	IHYFCDO100	56630.00	IHYFCDE100	69200.00
125 A	IHYFCDO125	60750.00	IHYFCDE125	72730.00
160 A	IHYFCDO160	67050.00	IHYFCDE160	79985.00
200 A	IHYFCDO200	81010.00	IHYFCDE200	93335.00
250 A	IHYFCDO250	90855.00	IHYFCDE250	103540.00
315 A	IHYFCDO315	94980.00	IHYFCDE315	107300.00
400 A	IHYFCDO400	108730.00	IHYFCDE400	130185.00
500 A	IHYFCDO500	126580.00	IHYFCDE500	147605.00
630 A	IHYFCDO630	139520.00	IHYFCDE630	160550.00



## ATS Wire Harness

HSN Code: 85389000

Item Code	Per Unit LP (₹)
ISSYAX0201	3560.00

# Euroload (ON-Load) Changeover Switch (4 Pole) I-0-II

(Conforms to IS/IEC:60947-3)

HSN Code: 85365090

Frame Size	Rating (A)	Open Execution Item Code	Per Unit LP (₹)	SS Enclosure Item Code	Per Unit LP (₹)
00	040 A	IHCNFO0040	5785.00	IHCNFE0040	8265.00
00	063 A	IHCNFO0063	6080.00	IHCNFE0063	8805.00
00	100 A	IHCNFO0100	8150.00	IHCNFE0100	11095.00
0	125 A	IHCNFO0125	12170.00	IHCNFE0125	16635.00
0	160 A	IHCNFO0160	13040.00	IHCNFE0160	17720.00
0	200 A	IHCNFO0200	15640.00	IHCNFE0200	20410.00
1	250 A	IHCNFO0250	22625.00	IHCNFE0250	28230.00
1	320 A	IHCNFO0320	23905.00	IHCNFE0320	29525.00
2	400 A	IHCNFO0400	34545.00	IHCNFE0400	43445.00
2	630 A	IHCNFO0630	41045.00	IHCNFE0630	50275.00
3	800 A	IHCNFO0800	59730.00	IHCNFE0800	75875.00
4	1000 A	IHCNFO1000	101730.00	IHCNFE1000	138290.00
4	1250 A	IHCNFO1250	135060.00	IHCNFE1250	185135.00
4	1600 A	IHCNFO1600	160845.00	IHCNFE1600	248615.00
5	2000 A	IHCNFO2000	249200.00	IHCNFE2000	327575.00
5	2500 A	IHCNFO2500	330520.00	IHCNFE2500	418215.00
5	3150 A	IHCNFO3150	452500.00	IHCNFE3150	566570.00



Note :  
Phase Barriers & Handle with door interlock kit is integral part of the Changeover Switch.  
Aux. contacts for signalling and electrical interlocking are optional and provided at extra price.  
For motorised changeover please contact with nearest branch.

## Euroload By Pass Switch

Conforms to IS:13947 (Part-3); IEC:60947-3

Four Pole, 415 V

HSN Code: 85365090

Frame Size	Current Rating (A)	Open Execution Item Code	Per Unit LP (₹)
00	063 A	IHCBFO0063	10910.00
00	100 A	IHCBFO0100	12865.00
0	125 A	IHCBFO0125	16390.00
0	160 A	IHCBFO0160	19525.00
0	200 A	IHCBFO0200	20995.00
1	250 A	IHCBFO0250	30375.00
1	320 A	IHCBFO0320	32095.00
2	400 A	IHCBFO0400	46385.00
2	630 A	IHCBFO0630	55110.00
3	800 A	IHCBFO0800	82490.00
3	1000 A	IHCBFO1000	140480.00
3	1600 A	IHCBFO1600	222130.00

## Accessories

HSN Code: 85389000

Aux. Contact	Item Code	Per Unit LP (₹)
1 NO. 1 NC.	IHCNFAC1CO	410.00
2 NO. 2 NC.	IHCNFAC2CO	550.00



## Euroload Switch Disconnecter

(Conforms to IS/IEC:60947-3)

Three Pole, 415 V

HSN Code: 85365090

Frame Size	Current Rating A	Open Execution Item Code	Per Unit LP (₹)	SS Enclosure Item Code	Per Unit LP (₹)
0	80 A	IHCSTO0080	2060.00	IHCSTE0080	3205.00
0	100 A	IHCSTO0100	3120.00	IHCSTE0100	4435.00
0	125 A	IHCSTO0125	4155.00	IHCSTE0125	5395.00
0	160 A	IHCSTO0160	4945.00	IHCSTE0160	6820.00
0	200 A	IHCSTO0200	5620.00	IHCSTE0200	6960.00
1	250 A	IHCSTO0250	7020.00	IHCSTE0250	8940.00
1	320 A	IHCSTO0320	7705.00	IHCSTE0320	9800.00
1	400 A	IHCSTO0400	11100.00	IHCSTE0400	13370.00



## Euroload Switch Disconnecter

Four Pole, 415 V

HSN Code: 85365090

Frame Size	Current Rating A	Open Execution Item Code	Per Unit LP (₹)	SS Enclosure Item Code	Per Unit LP (₹)
00	40 A	IHCSFO0040	1505.00	IHCSFE0040	2470.00
00	63 A	IHCSFO0063	1700.00	IHCSFE0063	2695.00
00	80 A	IHCSFO0080	2520.00	IHCSFE0080	3420.00
00	100 A	IHCSFO0100	4065.00	IHCSFE0100	4970.00
0	125 A	IHCSFO0125	4330.00	IHCSFE0125	5480.00
0	160 A	IHCSFO0160	5185.00	IHCSFE0160	6330.00
0	200 A	IHCSFO0200	6260.00	IHCSFE0200	7560.00
1	250 A	IHCSFO0250	7845.00	IHCSFE0250	10170.00
1	320 A	IHCSFO0320	8600.00	IHCSFE0320	10800.00
2	400 A	IHCSFO0400	11930.00	IHCSFE0400	14910.00
2	630 A	IHCSFO0630	13660.00	IHCSFE0630	16835.00
3	800 A	IHCSFO0800	20365.00	IHCSFE0800	24025.00
4	1000 A	IHCSFO1000	30805.00	IHCSFE1000	43645.00
4	1250 A	IHCSFO1250	46270.00	IHCSFE1250	52500.00
4	1600 A	IHCSFO1600	63670.00	IHCSFE1600	70595.00
5	2000 A	IHCSFO2000	72965.00	IHCSFE2000	92950.00
5	2500 A	IHCSFO2500	94685.00	IHCSFE2500	121665.00
5	3150 A	IHCSFO3150	133570.00	IHCSFE3150	172915.00



# Kompact *plus* Switch Disconnecter Fuse

(Conforms to IS/IEC:60947- Part 1 & 3)

Switch Disconnecter Fuse (Panel Mounting Cubicle Type) - AC-23A, 50 Hz, 415 V  
Kompact Plus



HSN Code: 85371000

Rating A	Pole	Type of Fuse	With / Without Fuse	Item Code	Per Unit LP (₹)	Item Code	Per Unit LP (₹)	Suitable Fuse
				Open Execution		In Sheet Steel Encl.		
32 A	TPN	Bolted Type	With 3 Fuses	IHKDTF4032	2790.00	IHKDTW4032	4495.00	IHHTIA0032
63 A				IHKDTF4063	3840.00	IHKDTW4063	5560.00	IHHTSS0063
100 A				IHKDTF4100	7775.00	IHKDTW4100	9385.00	IHHTSD0100
125 A				IHKDTF4125	9945.00	IHKDTW4125	11645.00	IHHTSD0125
32 A		Bolted Type	Without Fuse	IHKDTO4032	2430.00	IHKDTE4032	4135.00	IHHTIA0032
63 A				IHKDTO4063	3395.00	IHKDTE4063	5120.00	IHHTSS0063
100 A				IHKDTO4100	6855.00	IHKDTE4100	8475.00	IHHTSD0100
125 A				IHKDTO4125	9025.00	IHKDTE4125	10725.00	IHHTSD0125
32 A	FP	Bolted Type	With 4 Fuses	IHKDF4032	3810.00	IHKDFW4032	5630.00	IHHTIA0032
63 A				IHKDF4063	4865.00	IHKDFW4063	6690.00	IHHTSS0063
100 A				IHKDF4100	9750.00	IHKDFW4100	11580.00	IHHTSD0100
125 A				IHKDF4125	11865.00	IHKDFW4125	13790.00	IHHTSD0125
32 A		Bolted Type	Without Fuse	IHKDFO4032	3335.00	IHKDFE4032	5155.00	IHHTIA0032
63 A				IHKDFO4063	4275.00	IHKDFE4063	6100.00	IHHTSS0063
100 A				IHKDFO4100	8520.00	IHKDFE4100	10360.00	IHHTSD0100
125 A				IHKDFO4125	10640.00	IHKDFE4125	12565.00	IHHTSD0125
32 A	TPN	DIN Type	With 3 Fuses	IHKFTF4032	3975.00	IHKFTW4032	5315.00	IHHCD00032
63 A				IHKFTF4063	5055.00	IHKFTW4063	6540.00	IHHCD00063
100 A				IHKFTF4100	8645.00	IHKFTW4100	10315.00	IHHCD00100
125 A				IHKFTF4125	11050.00	IHKFTW4125	12745.00	IHHCD00125
32 A		DIN Type	Without Fuse	IHKFTO4032	2625.00	IHKFTE4032	3965.00	IHHCD00032
63 A				IHKFTO4063	3655.00	IHKFTE4063	5140.00	IHHCD00063
100 A				IHKFTO4100	7110.00	IHKFTE4100	8780.00	IHHCD00100
125 A				IHKFTO4125	9480.00	IHKFTE4125	11180.00	IHHCD00125
32 A	FP	DIN Type	With 4 Fuses	IHKFFF4032	5410.00	IHKFFW4032	6840.00	IHHCD00032
63 A				IHKFFF4063	6530.00	IHKFFW4063	8095.00	IHHCD00063
100 A				IHKFFF4100	11185.00	IHKFFW4100	12950.00	IHHCD00100
125 A				IHKFFF4125	12370.00	IHKFFW4125	14120.00	IHHCD00125
32 A		DIN Type	Without Fuse	IHKFFO4032	3605.00	IHKFFE4032	5035.00	IHHCD00032
63 A				IHKFFO4063	4660.00	IHKFFE4063	6230.00	IHHCD00063
100 A				IHKFFO4100	9135.00	IHKFFE4100	10910.00	IHHCD00100
125 A				IHKFFO4125	10280.00	IHKFFE4125	12030.00	IHHCD00125

# Kompact *plus* Switch Disconnecter Fuse Unit

(Conforms to IS/IEC:60947- Part 1 & 3)

Switch Disconnecter Fuse (Panel Mounting Cubicle Type) - AC-23 A, 50 Hz, 415 V  
Kompact EZO



TPN

HSN Code: 85371000

Rating A	Pole	Type of Fuse		Item Code	Per Unit LP (₹)	Item Code	Per Unit LP (₹)	Suitable Fuse		
				Open Execution		In Sheet Steel Encl.				
160 A	TPN	Bolted Type	With 3 Fuses	IHFSTF4160	11200.00	IHFSTW4160	14455.00	IHHTSF0160		
200 A				IHFSTF4200	14570.00	IHFSTW4200	17750.00	IHHTSF0200		
250 A				IHFSTF4250	17150.00	IHFSTW4250	20225.00	IHHTSF0250		
320 A				IHFSTF4320	20920.00	IHFSTW4320	24515.00	IHHTSK0315		
400 A				IHFSTF4400	26415.00	IHFSTW4400	29820.00	IHHTSMF400		
630 A				IHFSTF4630	44140.00	IHFSTW4630	47605.00	IHHTLM0630		
800 A				IHFSTF4800	51650.00	IHFSTW4800	55045.00	IHHTLM0800		
160 A				Bolted Type	Without Fuse	IHFSTO4160	9780.00	IHFSTE4160	13040.00	IHHTSF0160
200 A		IHFSTO4200	13135.00			IHFSTE4200	16320.00	IHHTSF0200		
250 A		IHFSTO4250	15605.00			IHFSTE4250	18680.00	IHHTSF0250		
320 A		IHFSTO4320	18930.00			IHFSTE4320	22525.00	IHHTSK0315		
400 A		IHFSTO4400	22675.00			IHFSTE4400	26080.00	IHHTSMF400		
630 A		IHFSTO4630	36550.00			IHFSTE4630	40015.00	IHHTLM0630		
800 A		IHFSTO4800	43190.00			IHFSTE4800	46580.00	IHHTLM0800		
160 A		DIN Type	With 3 Fuses			IHFKTF4160	12380.00	IHFKTW4160	15380.00	IHHCD01160
200 A				IHFKTF4200	15115.00	IHFKTW4200	18800.00	IHHCD01200		
250 A				IHFKTF4250	17720.00	IHFKTW4250	21205.00	IHHCD01250		
320 A				IHFKTF4320	21970.00	IHFKTW4320	25335.00	IHHCD02315		
400 A				IHFKTF4400	26135.00	IHFKTW4400	29480.00	IHHCD02400		
630 A				IHFKTF4630	41960.00	IHFKTW4630	45550.00	IHHCD03630		
160 A				DIN Type	Without Fuse	IHFKTO4160	10110.00	IHFKTE4160	13110.00	IHHCD01160
200 A						IHFKTO4200	12850.00	IHFKTE4200	16530.00	IHHCD01200
250 A		IHFKTO4250	15165.00			IHFKTE4250	18650.00	IHHCD01250		
320 A		IHFKTO4320	18685.00			IHFKTE4320	22045.00	IHHCD02315		
400 A		IHFKTO4400	22600.00			IHFKTE4400	25940.00	IHHCD02400		
630 A		IHFKTO4630	36385.00			IHFKTE4630	39980.00	IHHCD03630		
800 A		IHFKTO4800	39470.00	IHFKTE4800	43980.00	IHHCD03800				

# Kompact *plus* Switch Disconnecter Fuse

(Conforms to IS/IEC:60947- Part 1 & 3)

Four Pole

HSN Code: 85371000

Rating A	Pole	Type of Fuse		Item Code	Per Unit LP (₹)	Item Code	Per Unit LP (₹)	Suitable Fuse
				Open Execution		In Sheet Steel Encl.		
160 A	FP	Bolted Type	With 4 Fuses	IHFSFF4160	15355.00	IHFSFW4160	18490.00	IHHTSF0160
200 A				IHFSFF4200	18045.00	IHFSFW4200	21010.00	IHHTSF0200
250 A				IHFSFF4250	20680.00	IHFSFW4250	23530.00	IHHTSF0250
320 A				IHFSFF4320	23665.00	IHFSFW4320	26880.00	IHHTSK0315
400 A				IHFSFF4400	29055.00	IHFSFW4400	32800.00	IHHTSMF400
630 A				IHFSFF4630	48555.00	IHFSFW4630	52365.00	IHHTLM0630
800 A				IHFSFF4800	56815.00	IHFSFW4800	60545.00	IHHTLM0800
160 A		Bolted Type	Without Fuse	IHFSFO4160	13470.00	IHFSFE4160	16610.00	IHHTSF0160
200 A				IHFSFO4200	16140.00	IHFSFE4200	19110.00	IHHTSF0200
250 A				IHFSFO4250	18615.00	IHFSFE4250	21465.00	IHHTSF0250
320 A				IHFSFO4320	21015.00	IHFSFE4320	24775.00	IHHTSK0315
400 A				IHFSFO4400	24945.00	IHFSFE4400	28690.00	IHHTSMF400
630 A				IHFSFO4630	40200.00	IHFSFE4630	44010.00	IHHTLM0630
800 A				IHFSFO4800	47505.00	IHFSFE4800	51235.00	IHHTLM0800
160 A		DIN Type	With 4 Fuses	IHFKFF4160	14600.00	IHFKFW4160	17395.00	IHHCD01160
200 A				IHFKFF4200	18385.00	IHFKFW4200	21190.00	IHHCD01200
250 A				IHFKFF4250	19495.00	IHFKFW4250	23320.00	IHHCD01250
320 A				IHFKFF4320	24170.00	IHFKFW4320	27870.00	IHHCD02315
400 A				IHFKFF4400	28750.00	IHFKFW4400	32425.00	IHHCD02400
630 A				IHFKFF4630	48830.00	IHFKFW4630	52070.00	IHHCD03630
800 A				IHFKFF4800	56815.00	IHFKFW4800	60545.00	IHHCD03800
160 A		DIN Type	Without Fuse	IHFKFO4160	11570.00	IHFKFE4160	14375.00	IHHCD01160
200 A				IHFKFO4200	15360.00	IHFKFE4200	18165.00	IHHCD01200
250 A				IHFKFO4250	16680.00	IHFKFE4250	20510.00	IHHCD01250
320 A	IHFKFO4320			20555.00	IHFKFE4320	24255.00	IHHCD02315	
400 A	IHFKFO4400			24860.00	IHFKFE4400	28530.00	IHHCD02400	
630 A	IHFKFO4630			41405.00	IHFKFE4630	44640.00	IHHCD03630	
800 A	IHFKFO4800			47925.00	IHFKFE4800	52395.00	IHHCD03800	

## Accessories NEW

HSN Code: 85389000

Cat Code	Description	Per Unit LP (₹)
ISSCBX0001	1 NO-NC SWITCH FOR SDF (32A-125A)	590.00
ISSCBX0002	1 NO-NC SWITCH FOR SDF (160A-800A)	705.00
ISSCBX0003	2 NO-NC SWITCH FOR SDF (32A-125A)	1060.00
ISSCBX0004	2 NO-NC SWITCH FOR SDF 160A-800A)	1175.00

# HiBreak HBC Fuse Link

(Conforms to IS: 13703-1 & 2-1 / IEC:60269-1 & 2-1)

## RH Type HRC Fuse- 80 kA, 415 V

Rating (A)	Item Code	Per Unit LP (₹)	STD Packing No. of unit/s	HSN Code
2 A	IHHRH00002	140.00	20 N	85361010
6 A	IHHRH00006			
10 A	IHHRH00010			
16 A	IHHRH00016			85361020
20 A	IHHRH00020			
25 A	IHHRH00025			
32 A	IHHRH00032	150.00	20 N	85361020
40 A	IHHRH00040			
50 A	IHHRH00050			
63 A	IHHRH00063	380.00	20 N	



## DIN Fuse Bases (Fixed Type)

Specification: IEC: 60269-1 & 2-1 / IS: 13703-1 & 2-1.

HSN Code: 85361020

Rated A	Item Code	Type	Fuse Type	Per Unit LP (₹)	STD Packing No. of unit/s
160 A	IHUC000160	Open Type Fuse Base	CD-00	480.00	6 N



## i Base - DIN Fuse Bases (Fixed Type)

Specification: IEC: 60269-1 & 2-1 / IS: 13703-1 & 2-1.

HSN Code: 85361020

Rated A	Item Code	Type	Fuse Type	Per Unit LP (₹)	STD Packing No. of unit/s
250 A	IHIC01O250	Open Type Fuse Base	CD-1	960.00	3 N
400 A	IHIC02O400	Open Type Fuse Base	CD-2	1540.00	3 N
630 A	IHIC03O630	Open Type Fuse Base	CD-3	1795.00	3 N
800 A	IHIC03O800	Open Type Fuse Base	CD-3	1795.00	3 N



# HiBreak HBC Fuse Link

(Conforms to IS: 13703-1 & 2-1 / IEC:60269-1 & 2-1)



Bolted Type HRC Fuse - 80 kA, 415 V

IS Size	Tag Type	BS Type	Rating (A)	Item Code	Per Unit LP (₹)	STD Packing No. of unit/s
<b>HSN Code: 85361010</b>						
F-1	Offset	NS	2 A	IHHNS00002	80.00	20 N
			4 A	IHHNS00004		
			6 A	IHHNS00006		
			10 A	IHHNS00010		
<b>HSN Code: 85361020</b>						
F-1	Offset	NS	16 A	IHHNS00016	80.00	20 N
			20 A	IHHNS00020	90.00	
			25 A	IHHNS00025		
			32 A	IHHNS00032		
A-2	Offset	TIA	16 A	IHHTIA0016	115.00	10 N
			20 A	IHHTIA0020		
			25 A	IHHTIA0025		
			32 A	IHHTIA0032		
A-3	Offset	TSS	40 A	IHHTSS0040	140.00	10 N
			50 A	IHHTSS0050		
			63 A	IHHTSS0063		
A-4	Offset	TSD	80 A	IHHTSD0080	305.00	10 N
			100 A	IHHTSD0100		
			125 A	IHHTSD0125		
B-1	Central	TSDC	80 A	IHHTSDC080	310.00	10 N
			100 A	IHHTSDC100		
			125 A	IHHTSDC125		
B-2	Central	TSF	160 A	IHHTSF0160	455.00	10 N
			200 A	IHHTSF0200	490.00	
			250 A	IHHTSF0250		
B-3	Central	TSK	315 A	IHHTSK0315	645.00	3 N
B-4	Central	TSMF	400 A	IHHTSMF400	1210.00	3 N
C-1	Central	TSMS	400 A	IHHTSMS400		3 N
C-2	Central	TTS	400 A	IHHTTS0400	1380.00	1 N
C-2	Central	TLM	630 A	IHHTLM0630	2455.00	1 N
C-2	Central	TLM	800 A	IHHTLM0800	2740.00	1 N



DIN Type HRC Fuse - 80 kA, 415 V

IS Size	Rating (A)	Item Code	Per Unit LP (₹)	STD Packing No. of unit/s
<b>HSN Code: 85361020</b>				
000	32 A	IHHCD11032	385.00	3 N
	63 A	IHHCD11063	395.00	
	100 A	IHHCD11100	425.00	
<b>HSN Code: 85361010</b>				
00	6 A	IHHCD00006	435.00	3 N
	10 A	IHHCD00010		
<b>HSN Code: 85361020</b>				
00	16 A	IHHCD00016	435.00	3 N
	25 A	IHHCD00025		
	32 A	IHHCD00032		
	40 A	IHHCD00040		
	50 A	IHHCD00050		
	63 A	IHHCD00063		
	80 A	IHHCD00080		
	100 A	IHHCD00100		
	125 A	IHHCD00125		
	160 A	IHHCD00160		
01	40 A	IHHCD01040	725.00	3 N
	50 A	IHHCD01050		
	100 A	IHHCD01100		
	125 A	IHHCD01125		
	160 A	IHHCD01160		
	200 A	IHHCD01200		
02	250 A	IHHCD01250	825.00	1 N
	250 A	IHHCD02250	1065.00	
	315 A	IHHCD02315	1145.00	
	350 A	IHHCD02350		
03	400 A	IHHCD02400	1145.00	1 N
	500 A	IHHCD03500	1765.00	
	630 A	IHHCD03630	1805.00	
	800 A	IHHCD03800	2230.00	

# Power Quality Solutions

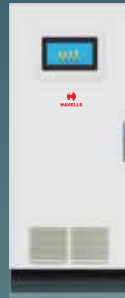

**AHF System**  
Active Harmonic Filter / SVG



**Contactor / Thyristor**  
Switching APFC Panel



**Harmonic Duty (MPP)**  
Power Capacitor



**IOT Based / GSM**  
IPFC RELAY



**Capacitor Duty**  
Contactor



**High Linearity**  
Detuned Reactor



**High PIV**  
Thyristor Switch

# Power Quality Solutions

## MPP Power Capacitor



### Power Capacitors

Parameters	Splendid Duty	Heavy Duty Plus / Heavy Duty	Super Heavy Duty
Type	MPP	MPP	MPP
Over Current withstand capacity upto	1.6 X Ir	2.4 X Ir / 2.2 Ir	3.2 X Ir / 3.0 X Ir
Peak Inrush Current Withstand Capacity upto	250 times	350 times / 350 times	500 times / 500 times
Total Losses	≤0.45 W / kVAr	≤0.45 W / kVAr	≤0.45 W / kVAr
No of switching per year	35000	50000 / 52500	65000 / 80000
Max Ambient Temp (°C)	55 °C	55 °C	55 °C
Operating life in hours	120000	200000 / 215000	250000 / 300000
Notch Shield	Yes	Yes	Yes
Over pressure Disconnecter	Yes	Yes	Yes
Triple Safety	Yes	Yes	Yes

### Selection of Capacitor

Selection of Capacitor Type is first decision to be made  
 Power Factor Correction Capacitor can be classified as follows.  
 Splendid Duty - Torrent and Master  
 Heavy Duty - Champ  
 SHD / UHDXL- Warrior and Champion (Double Di-electric)

### Refer following table for the capacitor duty based on type of Industry / Application

Power Capacitor Selection Chart on the basis of Application				
% Non linear load	≤ 10%	Up to 15%	Up to 20%	Between 20% to 30%
<b>Square</b>	<b>Master Splendid Duty</b>	<b>Champ HD Plus</b>	<b>Champion UHDXL</b>	<b>Champ HD Plus + Reactor</b>
<b>Cylindrical</b>	<b>Torrent Splendid Duty</b>	<b>Warrior SHD</b>	<b>Warrior SHD</b>	<b>Warrior SHD + Reactor</b>
Application	These Capacitors are designed for normal loads where non linear factor is ≤10% THD I. Do not use normal duty capacitors for the application of Heavy Duty and Super Heavy Duty capacitors.	<15% THD I. Commercial building with CFL lamps, SMPS, UPS etc.	<20% THD I. Heavy Chemical Industries	<25% THD I. Steel plant
		Garment industries (Sewing Industry)	Pharmaceutical Industries	Cement Industries
		Bakeries	Automobile plants	Stone crushing
		Flour mills	Paper Industries	Textiles (Production of Yarn/cloth)
		Oil mills	Food processing plants	Forging Industries
		Glass industries	IT Industries	Power frequency induction furnaces
		Rice mills	Fabrication shops	Sugar plants
		Cold storage	Welding shops	Rolling mills
			Machine and tool shop	
Example for Calculating Non Linear Load Installed Transformer Rating = 1000 kVA Non Linear Loads = 100 kVA $\% \text{ Non Linear Load} = (\text{Non Linear Load} / \text{Transformer Rating}) \times 100$ $= (100/1000) \times 100$ $= 10\%$				
Example of Non Linear Loads: UPS, Arc / Induction furnace, Rectifiers, AC / DC Drives, Computer, CFL, CNC Machines.				

Current Power Factor Cos φ	Achievable (Target) Cos φ					Target Cos φ = 0.96	Q				
	0.90	0.91	0.92	0.94	0.95	0.96	0.97	0.98	0.99	1	
0.51	1.20	1.23	1.26	1.32	1.36	1.40	1.44	1.48	1.54	1.69	
0.52	1.16	1.19	1.22	1.28	1.31	1.35	1.39	1.44	1.50	1.64	
0.53	1.11	1.14	1.17	1.24	1.27	1.30	1.35	1.40	1.46	1.60	
0.54	1.08	1.10	1.13	1.20	1.23	1.27	1.31	1.36	1.42	1.56	
0.55	1.04	1.06	1.09	1.16	1.19	1.23	1.27	1.32	1.38	1.52	
0.56	1.00	1.02	1.05	1.12	1.15	1.19	1.23	1.28	1.34	1.48	
0.57	0.96	0.99	1.02	1.08	1.11	1.15	1.19	1.24	1.30	1.44	
0.58	0.92	0.95	0.98	1.04	1.08	1.11	1.15	1.20	1.26	1.41	
0.59	0.89	0.91	0.94	1.01	1.04	1.08	1.12	1.17	1.23	1.37	
0.60	0.85	0.88	0.91	0.97	1.00	1.04	1.08	1.13	1.19	1.33	
0.61	0.82	0.84	0.87	0.94	0.97	1.01	1.05	1.10	1.16	1.30	
0.62	0.78	0.81	0.84	0.90	0.94	0.97	1.02	1.06	1.12	1.27	
0.63	0.75	0.78	0.81	0.87	0.90	0.94	0.98	1.03	1.09	1.23	
0.64	0.72	0.75	0.78	0.84	0.87	0.91	0.95	1.00	1.07	1.20	
0.65	0.69	0.71	0.74	0.81	0.84	0.88	0.92	0.97	1.03	1.17	
0.66	0.65	0.68	0.71	0.77	0.81	0.85	0.89	0.94	1.00	1.14	
0.67	0.62	0.65	0.68	0.74	0.78	0.82	0.86	0.91	0.97	1.11	
0.68	0.59	0.62	0.65	0.71	0.75	0.79	0.83	0.88	0.94	1.08	
0.69	0.57	0.59	0.62	0.68	0.72	0.76	0.80	0.85	0.91	1.05	
0.70	0.54	0.56	0.59	0.65	0.69	0.73	0.77	0.82	0.88	1.02	
0.71	0.51	0.54	0.57	0.63	0.66	0.70	0.74	0.79	0.85	0.99	
0.72	0.48	0.51	0.54	0.60	0.64	0.67	0.71	0.76	0.82	0.96	
0.73	0.45	0.48	0.51	0.57	0.61	0.64	0.69	0.73	0.79	0.94	
0.74	0.43	0.45	0.48	0.54	0.58	0.62	0.66	0.71	0.77	0.91	
0.75	0.40	0.43	0.46	0.51	0.55	0.59	0.63	0.68	0.74	0.88	
0.76	0.37	0.40	0.43	0.49	0.53	0.56	0.60	0.65	0.71	0.86	
0.77	0.35	0.37	0.40	0.46	0.50	0.44	0.58	0.63	0.69	0.83	
0.78	0.32	0.35	0.38	0.43	0.47	0.51	0.55	0.60	0.66	0.80	
0.79	0.29	0.32	0.35	0.41	0.45	0.48	0.53	0.57	0.63	0.78	
0.80	0.27	0.29	0.32	0.38	0.42	0.46	0.50	0.55	0.61	0.75	
0.81	0.24	0.27	0.30	0.36	0.40	0.43	0.47	0.52	0.58	0.72	
0.82	0.21	0.24	0.27	0.33	0.37	0.41	0.45	0.50	0.56	0.70	
0.83	0.19	0.22	0.25	0.30	0.34	0.38	0.42	0.47	0.53	0.67	
0.84	0.16	0.19	0.22	0.28	0.32	0.35	0.40	0.44	0.50	0.65	
0.85	0.14	0.16	0.19	0.25	0.29	0.33	0.37	0.42	0.48	0.62	
0.86	0.11	0.14	0.17	0.23	0.26	0.30	0.34	0.39	0.45	0.59	
0.87	0.08	0.11	0.14	0.20	0.24	0.28	0.32	0.36	0.43	0.57	
0.88	0.06	0.08	0.11	0.17	0.21	0.25	0.29	0.34	0.40	0.54	
0.89	0.03	0.06	0.09	0.15	0.18	0.22	0.26	0.31	0.37	0.51	
0.90	0.00	0.03	0.08	0.12	0.16	0.19	0.23	0.28	0.34	0.48	
0.91		0.00	0.03	0.09	0.13	0.16	0.21	0.25	0.31	0.46	
0.92			0.00	0.06	0.10	0.13	0.18	0.22	0.28	0.43	
0.93				0.03	0.07	0.10	0.14	0.19	0.25	0.40	
0.94				0.00	0.03	0.07	0.11	0.16	0.22	0.36	
0.95					0.00	0.04	0.08	0.13	0.19	0.33	

**Calculation of Required kVAR**

Operating load kW and its average power factor (PF) as per the electricity bill OR we can easily calculate by a simple formula

Average PF = kW / kVA Operating load kW = kVA Demand x Average PF

Average PF is considered as the initial PF and the final PF is assumed as a target PF. From this information required kVAR can be easily calculated with reference table.

Example: Calculate required kVAR to improve PF from 0.75 to 0.96 for 500 kW installation

kVAR = kW x multiplying factor from table = 500 x 0.590 = 295 kVAR

## Hercules - Normal Duty Single Phase Cylindrical Capacitors

- Design in Cylindrical Aluminium case.
- Output range 1 kVAr to 5 kVAr.
- Compact volume, low weight
- Easy connection and installation



HSN Code: 85321000

Rating kVAr	Item Code	Description	Standard Pack No of unit/s	Master Pack No of unit/s	Per Unit LP (₹)
<b>Rated Voltage 250 Vac, 1<math>\phi</math>, 50 Hz</b>					
1 kVAr	QHNSCS5001X0	HERCULES 250 V 50 Hz-1 kVAr 1 PH	1 N	16 N	<b>487.00</b>
2 kVAr	QHNSCS5002X0	HERCULES 250 V 50 Hz-2 kVAr 1 PH	1 N	16 N	<b>675.00</b>
3 kVAr	QHNSCS5003X0	HERCULES 250 V 50 Hz-3 kVAr 1 PH	1 N	16 N	<b>1024.00</b>
4 kVAr	QHNSCS5004X0	HERCULES 250 V 50 Hz-4 kVAr 1 PH	1 N	16 N	<b>1345.00</b>
5 kVAr	QHNSCS5005X0	HERCULES 250 V 50 Hz-5 kVAr 1 PH	1 N	8 N	<b>1664.00</b>

## Torrent - Splendid Duty Cylindrical Capacitors

- Design in Cylindrical Aluminium case.
- Output range 1 kVAr to 30 kVAr.
- Long life expectancy upto 120000 Hours
- Compact volume, low weight
- Easy connection and installation



HSN Code: 85321000

Rating kVAr	Item Code	Description	Standard Pack No of unit/s	Master Pack No of unit/s	Per Unit LP (₹)
<b>Rated Voltage 440 Vac, 3<math>\phi</math>, 50 Hz, Delta Connection</b>					
1 kVAr	QHUTCC5001X0	Torrent 440 V 50 Hz-1 kVAr 3 PH	1 N	16 N	<b>375.00</b>
2 kVAr	QHUTCC5002X0	Torrent 440 V 50 Hz-2 kVAr 3 PH	1 N	16 N	<b>575.00</b>
3 kVAr	QHUTCC5003X0	Torrent 440 V 50 Hz-3 kVAr 3 PH	1 N	16 N	<b>900.00</b>
4 kVAr	QHUTCC5004X0	Torrent 440 V 50 Hz-4 kVAr 3 PH	1 N	16 N	<b>1000.00</b>
5 kVAr	QHUTCC5005X0	Torrent 440 V 50 Hz-5 kVAr 3 PH	1 N	16 N	<b>1144.00</b>
6 kVAr	QHUTCC5006X0	Torrent 440 V 50 Hz-6 kVAr 3 PH	1 N	16 N	<b>1372.00</b>
7.5 kVAr	QHUTCC5007X5	Torrent 440 V 50 Hz-7.5 kVAr 3P H	1 N	16 N	<b>1715.00</b>
10 kVAr	QHUTCC5010X0	Torrent 440 V 50 Hz-10 kVAr 3 PH	1 N	8 N	<b>2287.00</b>
12.5 kVAr	QHUTCC5012X5	Torrent 440 V 50 Hz-12.5 kVAr 3 PH	1 N	8 N	<b>2859.00</b>
15 kVAr	QHUTCC5015X0	Torrent 440 V 50 Hz-15 kVAr 3 PH	1 N	4 N	<b>3430.00</b>
20 kVAr	QHUTCC5020X0	Torrent 440 V 50 Hz-20 kVAr 3 PH	1 N	4 N	<b>4573.00</b>
25 kVAr	QHUTCC5025X0	Torrent 440 V 50 Hz-25 kVAr 3 PH	1 N	4 N	<b>5717.00</b>
30 kVAr	QHUTCC5030X0	Torrent 440 V 50 Hz-30 kVAr 3 PH	1 N	4 N	<b>6860.00</b>

# Warrior - Super Heavy Duty Cylindrical Capacitors

- High inrush current withstand capability.
- Output range 1 kVAr to 30 kVAr.
- Soft sticky resin to withstand high temperature and current stress.
- Penta safety protection.
- Explosion proof, low losses & high over current withstand capabilities.



HSN Code: 85321000

Rating kVAr	Item Code	Description	Standard Pack No of unit/s	Master Pack No of unit/s	Per Unit LP (₹)
<b>Rated Voltage 440 Vac, 3<math>\phi</math>, 50 Hz, Delta Connection</b>					
1 kVAr	QHBTC5001X0	Warrior Super Heavy Duty 440 V 50 Hz 1 kVAr 3 PH	1 N	16 N	<b>495.00</b>
2 kVAr	QHBTC5002X0	Warrior Super Heavy Duty 440 V 50 Hz 2 kVAr 3 PH	1 N	16 N	<b>750.00</b>
3 kVAr	QHBTC5003X0	Warrior Super Heavy Duty 440 V 50 Hz 3 kVAr 3 PH	1 N	16 N	<b>936.00</b>
4 kVAr	QHBTC5004X0	Warrior Super Heavy Duty 440 V 50 Hz 4 kVAr 3 PH	1 N	16 N	<b>1248.00</b>
5 kVAr	QHBTC5005X0	Warrior Super Heavy Duty 440 V 50 Hz 5 kVAr 3 PH	1 N	16 N	<b>1622.00</b>
6 kVAr	QHBTC5006X0	Warrior Super Heavy Duty 440 V 50 Hz 7.5 kVAr 3 PH	1 N	8 N	<b>1946.00</b>
7.5 kVAr	QHBTC5007X5	Warrior Super Heavy Duty 440 V 50 Hz 6 kVAr 3 PH	1 N	8 N	<b>2432.00</b>
8 kVAr	QHBTC5008X0	Warrior Super Heavy Duty 440 V 50 Hz 8 kVAr 3 PH	1 N	8 N	<b>2593.00</b>
10 kVAr	QHBTC5010X0	Warrior Super Heavy Duty 440 V 50 Hz 10 kVAr 3 PH	1 N	8 N	<b>3242.00</b>
12.5 kVAr	QHBTC5012X5	Warrior Super Heavy Duty 440 V 50 Hz 12.5 kVAr 3 PH	1 N	4 N	<b>4052.00</b>
15 kVAr	QHBTC5015X0	Warrior Super Heavy Duty 440 V 50 Hz 15 kVAr 3 PH	1 N	4 N	<b>4863.00</b>
20 kVAr	QHBTC5020X0	Warrior Super Heavy Duty 440 V 50 Hz 20 kVAr 3 PH	1 N	4 N	<b>6484.00</b>
25 kVAr	QHBTC5025X0	Warrior Super Heavy Duty 440 V 50 Hz 25 kVAr 3 PH	1 N	4 N	<b>8105.00</b>
30 kVAr	QHBTC5030X0	Warrior Super Heavy Duty 440 V 50 Hz 30 kVAr 3 PH	1 N	4 N	<b>9726.00</b>
<b>Rated Voltage 480 Vac, 3<math>\phi</math>, 50 Hz, Delta Connection</b>					
5 kVAr	QHBTC5005X0	Warrior Super Heavy Duty 480 V 50 Hz 5 kVAr 3 PH	1 N	16 N	<b>1672.00</b>
7.5 kVAr	QHBTC5007X5	Warrior Super Heavy Duty 480 V 50 Hz 7.5 kVAr 3 PH	1 N	8 N	<b>2510.00</b>
10 kVAr	QHBTC5010X0	Warrior Super Heavy Duty 480 V 50 Hz 10 kVAr 3 PH	1 N	8 N	<b>3345.00</b>
12.5 kVAr	QHBTC5012X5	Warrior Super Heavy Duty 480 V 50 Hz 12.5 kVAr 3 PH	1 N	4 N	<b>4181.00</b>
15 kVAr	QHBTC5015X0	Warrior Super Heavy Duty 480 V 50 Hz 15 kVAr 3 PH	1 N	4 N	<b>5017.00</b>
20 kVAr	QHBTC5020X0	Warrior Super Heavy Duty 480 V 50 Hz 20 kVAr 3 PH	1 N	4 N	<b>6689.00</b>
25 kVAr	QHBTC5025X0	Warrior Super Heavy Duty 480 V 50 Hz 25 kVAr 3 PH	1 N	4 N	<b>8361.00</b>
30 kVAr	QHBTC5030X0	Warrior Super Heavy Duty 480 V 50 Hz 30 kVAr 3 PH	1 N	4 N	<b>10034.00</b>
<b>Rated Voltage 525 Vac, 3<math>\phi</math>, 50 Hz, Delta Connection</b>					
5 kVAr	QHBTC5005X0	Warrior Super Heavy Duty 525 V 50 Hz 5 kVAr 3 PH	1 N	16 N	<b>1672.00</b>
7.5 kVAr	QHBTC5007X5	Warrior Super Heavy Duty 525 V 50 Hz 7.5 kVAr 3 PH	1 N	8 N	<b>2510.00</b>
10 kVAr	QHBTC5010X0	Warrior Super Heavy Duty 525 V 50 Hz 10 kVAr 3 PH	1 N	8 N	<b>3345.00</b>
12.5 kVAr	QHBTC5012X5	Warrior Super Heavy Duty 525 V 50 Hz 12.5 kVAr 3 PH	1 N	4 N	<b>4181.00</b>
15 kVAr	QHBTC5015X0	Warrior Super Heavy Duty 525 V 50 Hz 15 kVAr 3 PH	1 N	4 N	<b>5017.00</b>
20 kVAr	QHBTC5020X0	Warrior Super Heavy Duty 525 V 50 Hz 20 kVAr 3 PH	1 N	4 N	<b>6689.00</b>
25 kVAr	QHBTC5025X0	Warrior Super Heavy Duty 525 V 50 Hz 25 kVAr 3 PH	1 N	4 N	<b>8361.00</b>
30 kVAr	QHBTC5030X0	Warrior Super Heavy Duty 525 V 50 Hz 30 kVAr 3 PH	1 N	4 N	<b>10034.00</b>

(IS: 13340 / IEC: 60831)

## Mini / Master - Splendid Duty Square Capacitors

- High inrush current withstand capability.
- Output range 1 kVAr to 50 kVAr.
- Soft sticky resin to withstand high temperature and current stress.
- Penta safety protection.
- Explosion proof, low losses & high over current withstand capabilities.



HSN Code: 85321000

Rating kVAr	Item Code	Description	Standard Pack No of unit/s	Master Pack No of unit/s	Per Unit LP (₹)
1 kVAr	QHNTMC5001X0	Mini Master 440 V 50 Hz-1 kVAr 3 PH	1 N	30 N	450.00
2 kVAr	QHNTMC5002X0	Mini Master 440 V 50 Hz-2 kVAr 3 PH	1 N	30 N	612.00
3 kVAr	QHNTMC5003X0	Mini Master 440 V 50 Hz-3 kVAr 3 PH	1 N	24 N	917.00
4 kVAr	QHNTMC5004X0	Mini Master 440 V 50 Hz-4 kVAr 3 PH	1 N	24 N	1221.00
5 kVAr	QHNTMC5005X0	Mini Master 440 V 50 Hz-5 kVAr 3 PH	1 N	24 N	1425.00
6 kVAr	QHNTMC5006X0	Master 440 V 50 Hz-6 kVAr 3 PH	1 N	1 N	1710.00
7.5 kVAr	QHNTMC5007X5	Master 440 V 50 Hz-7.5 kVAr 3 PH	1 N	1 N	2137.00
8 kVAr	QHNTMC5008X0	Master 440 V 50 Hz-8 kVAr 3 PH	1 N	1 N	2279.00
10 kVAr	QHNTMC5010X0	Master 440 V 50 Hz-10 kVAr 3 PH	1 N	1 N	2849.00
12.5 kVAr	QHNTMC5012X5	Master 440 V 50 Hz-12.5 kVAr 3 PH	1 N	1 N	3562.00
15 kVAr	QHNTMC5015X0	Master 440 V 50 Hz-15 kVAr 3 PH	1 N	1 N	4274.00
20 kVAr	QHNTMC5020X0	Master 440 V 50 Hz-20 kVAr 3 PH	1 N	1 N	5698.00
25 kVAr	QHNTMC5025X0	Master 440 V 50 Hz-25 kVAr 3 PH	1 N	1 N	7123.00
30 kVAr	QHNTMC5030X0	Master 440 V 50 Hz-30 kVAr 3 PH	1 N	1 N	8547.00
50 kVAr	QHNTMC5050X0	Master 440 V 50 Hz-50 kVAr 3 PH	1 N	1 N	14245.00



Other Ratings on request

Effective from 11th March, 2024

(IS: 13340 / IEC: 60831)

List Price (LP) are in Indian ₹ & as per Standard Terms & Conditions

**HAVELLS** 84

## Champ - Heavy Duty Plus Square Capacitors

- High inrush current withstand capability.
- Output range 1 kVAr to 100 kVAr.
- Soft sticky resin to withstand high temperature and current stress.
- Penta safety protection.
- Explosion proof, low losses & high over current withstand capabilities.



HSN Code: 85321000

Rating kVAr	Item Code	Description	Standard Pack No of unit/s	Master Pack No of unit/s	Per Unit LP (₹)
<b>Rated Voltage 440 Vac, 3<math>\phi</math>, 50 Hz, Delta Connection</b>					
1 kVAr	QHBTMC5001X0	Champ 440 V 50 Hz-1 kVAr 3 PH	1 N	30 N	500.00
2 kVAr	QHBTMC5002X0	Champ 440 V 50 Hz-2 kVAr 3 PH	1 N	30 N	822.00
3 kVAr	QHBTMC5003X0	Champ 440 V 50 Hz-3 kVAr 3 PH	1 N	24 N	1232.00
4 kVAr	QHBTMC5004X0	Champ 440 V 50 Hz-4 kVAr 3 PH	1 N	24 N	1645.00
5 kVAr	QHBTMC5005X0	Champ 440 V 50 Hz-5 kVAr 3 PH	1 N	1 N	1986.00
6 kVAr	QHBTMC5006X0	Champ 440 V 50 Hz-6 kVAr 3 PH	1 N	1 N	2383.00
7.5 kVAr	QHBTMC5007X5	Champ 440 V 50 Hz-7.5 kVAr 3 PH	1 N	1 N	2979.00
8 kVAr	QHBTMC5008X0	Champ 440 V 50 Hz-8 kVAr 3 PH	1 N	1 N	3178.00
10 kVAr	QHBTMC5010X0	Champ 440 V 50 Hz-10 kVAr 3 PH	1 N	1 N	3971.00
12.5 kVAr	QHBTMC5012X5	Champ 440 V 50 Hz-12.5 kVAr 3 PH	1 N	1 N	4966.00
15 kVAr	QHBTMC5015X0	Champ 440 V 50 Hz-15 kVAr 3 PH	1 N	1 N	5959.00
20 kVAr	QHBTMC5020X0	Champ 440 V 50 Hz-20 kVAr 3 PH	1 N	1 N	7944.00
25 kVAr	QHBTMC5025X0	Champ 440 V 50 Hz-25 kVAr 3PH	1 N	1 N	9930.00
30 kVAr	QHBTMC5030X0	Champ 440 V 50 Hz-30 kVAr 3 PH	1 N	1 N	11915.00
50 kVAr	QHBTMC5050X0	Champ 440 V 50 Hz-50 kVAr 3 PH	1 N	1 N	20886.00
75 kVAr	QHBTMC5075X0	Champ 440 V 50 Hz-75 kVAr 3 PH	1 N	1 N	31329.00
100 kVAr	QHBTMC5100X0	Champ 440 V 50 Hz-100 kVAr 3 PH	1 N	1 N	41772.00
<b>Rated Voltage 480 Vac, 3<math>\phi</math>, 50 Hz, Delta Connection</b>					
5 kVAr	QHBTMD5005X0	Champ 480 V 50 Hz-5 kVAr 3 PH	1 N	1 N	2137.00
6 kVAr	QHBTMD5006X0	Champ 480 V 50 Hz-6 kVAr 3 PH	1 N	1 N	2565.00
7.5 kVAr	QHBTMD5007X5	Champ 480 V 50 Hz-7.5 kVAr 3 PH	1 N	1 N	3205.00
10 kVAr	QHBTMD5010X0	Champ 480 V 50 Hz-10 kVAr 3 PH	1 N	1 N	4274.00
12.5 kVAr	QHBTMD5012X5	Champ 480 V 50 Hz-12.5 kVAr 3 PH	1 N	1 N	5342.00
15 kVAr	QHBTMD5015X0	Champ 480 V 50 Hz-15 kVAr 3 PH	1 N	1 N	6411.00
20 kVAr	QHBTMD5020X0	Champ 480 V 50 Hz-20 kVAr 3 PH	1 N	1 N	8547.00
25 kVAr	QHBTMD5025X0	Champ 480 V 50 Hz-25 kVAr 3 PH	1 N	1 N	10684.00
30 kVAr	QHBTMD5030X0	Champ 480 V 50 Hz-30 kVAr 3 PH	1 N	1 N	12820.00
50 kVAr	QHBTMD5050X0	Champ 480 V 50 Hz-50 kVAr 3 PH	1 N	1 N	21367.00
60 kVAr	QHBTMD5060X0	Champ 480 V 50 Hz-60 kVAr 3 PH	1 N	1 N	25640.00
<b>Rated Voltage 525 Vac, 3<math>\phi</math>, 50 Hz, Delta Connection</b>					
5 kVAr	QHBTMF5005X0	Champ 525 V 50 Hz-5 kVAr 3 PH	1 N	1 N	2137.00
6 kVAr	QHBTMF5006X0	Champ 525 V 50 Hz-6 kVAr 3 PH	1 N	1 N	2565.00
7.5 kVAr	QHBTMF5007X5	Champ 525 V 50 Hz-7.5 kVAr 3 PH	1 N	1 N	3205.00
10 kVAr	QHBTMF5010X0	Champ 525 V 50 Hz-10 kVAr 3 PH	1 N	1 N	4274.00
12.5 kVAr	QHBTMF5012X5	Champ 525 V 50 Hz-12.5 kVAr 3 PH	1 N	1 N	5342.00
15 kVAr	QHBTMF5015X0	Champ 525 V 50 Hz-15 kVAr 3 PH	1 N	1 N	6411.00
20 kVAr	QHBTMF5020X0	Champ 525 V 50 Hz-20 kVAr 3 PH	1 N	1 N	8547.00
25 kVAr	QHBTMF5025X0	Champ 525 V 50 Hz-25 kVAr 3 PH	1 N	1 N	10684.00
30 kVAr	QHBTMF5030X0	Champ 525 V 50 Hz-30 kVAr 3 PH	1 N	1 N	12820.00
50 kVAr	QHBTMF5050X0	Champ 525 V 50 Hz-50 kVAr 3 PH	1 N	1 N	22046.00
60 kVAr	QHBTMF5060X0	Champ 525 V 50 Hz-60 kVAr 3 PH	1 N	1 N	26455.00

(IS: 13340 / IEC: 60831)

## Champion - SHD Square Capacitors

- High inrush current withstand capability.
- Output range 1 kVAr to 100 kVAr.
- Soft sticky resin to withstand high temperature and current stress.
- Penta safety protection.
- Explosion proof, low losses & high over current withstand capabilities.



HSN Code: 85321000

Rating kVAr	Item Code	Description	Standard Pack No of unit/s	Master Pack No of unit/s	Per Unit LP (₹)
<b>Rated Voltage 440 Vac, 3<math>\phi</math>, 50 Hz, Delta Connection</b>					
1 kVAr	QHSTMC5001X0	Champion 440 V 50 Hz-1 kVAr 3 PH	1 N	16 N	1143.00
2 kVAr	QHSTMC5002X0	Champion 440 V 50 Hz-2 kVAr 3 PH	1 N	1 N	2285.00
3 kVAr	QHSTMC5003X0	Champion 440 V 50 Hz-3 kVAr 3 PH	1 N	1 N	3427.00
4 kVAr	QHSTMC5004X0	Champion 440 V 50 Hz-4 kVAr 3 PH	1 N	1 N	3973.00
5 kVAr	QHSTMC5005X0	Champion 440 V 50 Hz-5 kVAr 3 PH	1 N	1 N	4010.00
6 kVAr	QHSTMC5006X0	Champion 440 V 50 Hz-6 kVAr 3 PH	1 N	1 N	4535.00
7.5 kVAr	QHSTMC5007X5	Champion 440 V 50 Hz-7.5 kVAr 3 PH	1 N	1 N	5670.00
8 kVAr	QHSTMC5008X0	Champion 440 V 50 Hz-8 kVAr 3 PH	1 N	1 N	6048.00
10 kVAr	QHSTMC5010X0	Champion 440 V 50 Hz-10 kVAr 3 PH	1 N	1 N	7559.00
12.5 kVAr	QHSTMC5012X5	Champion 440 V 50 Hz-12.5 kVAr 3 PH	1 N	1 N	9449.00
15 kVAr	QHSTMC5015X0	Champion 440 V 50 Hz-15 kVAr 3 PH	1 N	1 N	11338.00
20 kVAr	QHSTMC5020X0	Champion 440 V 50 Hz-20 kVAr 3 PH	1 N	1 N	15118.00
25 kVAr	QHSTMC5025X0	Champion 440 V 50 Hz-25 kVAr 3 PH	1 N	1 N	18896.00
30 kVAr	QHSTMC5030X0	Champion 440 V 50 Hz-30 kVAr 3 PH	1 N	1 N	23684.00
50 kVAr	QHSTMC5050X0	Champion 440 V 50 Hz-50 kVAr 3 PH	1 N	1 N	39472.00
75 kVAr	QHSTMC5075X0	Champion 440 V 50 Hz-75 kVAr 3 PH	1 N	1 N	59208.00
100 kVAr	QHSTMC5100X0	Champion 440 V 50 Hz-100 kVAr 3 PH	1 N	1 N	78944.00
<b>Rated Voltage 480 Vac, 3<math>\phi</math>, 50 Hz, Delta Connection</b>					
5 kVAr	QHSTMD5005X0	Champion 480 V 50 Hz-5 kVAr 3 PH	1 N	1 N	4051.00
6 kVAr	QHSTMD5006X0	Champion 480 V 50 Hz-6 kVAr 3 PH	1 N	1 N	4581.00
7.5 kVAr	QHSTMD5007X5	Champion 480 V 50 Hz-7.5 kVAr 3 PH	1 N	1 N	5727.00
10 kVAr	QHSTMD5010X0	Champion 480 V 50 Hz-10 kVAr 3 PH	1 N	1 N	7635.00
12.5 kVAr	QHSTMD5012X5	Champion 480 V 50 Hz-12.5 kVAr 3 PH	1 N	1 N	9544.00
15 kVAr	QHSTMD5015X0	Champion 480 V 50 Hz-15 kVAr 3 PH	1 N	1 N	11453.00
20 kVAr	QHSTMD5020X0	Champion 480 V 50 Hz-20 kVAr 3 PH	1 N	1 N	15271.00
25 kVAr	QHSTMD5025X0	Champion 480 V 50 Hz-25 kVAr 3 PH	1 N	1 N	19087.00
30 kVAr	QHSTMD5030X0	Champion 480 V 50 Hz-30 kVAr 3 PH	1 N	1 N	23923.00
50 kVAr	QHSTMD5050X0	Champion 480 V 50 Hz-50 kVAr 3 PH	1 N	1 N	39871.00
60 kVAr	QHSTMD5060X0	Champion 480 V 50 Hz-60 kVAr 3 PH	1 N	1 N	47843.00
<b>Rated Voltage 525 Vac, 3<math>\phi</math>, 50 Hz, Delta Connection</b>					
5 kVAr	QHSTMF5005X0	Champion 525 V 50 Hz-5 kVAr 3 PH	1 N	1 N	4091.00
6 kVAr	QHSTMF5006X0	Champion 525 V 50 Hz-6 kVAr 3 PH	1 N	1 N	4627.00
7.5 kVAr	QHSTMF5007X5	Champion 525 V 50 Hz-7.5 kVAr 3 PH	1 N	1 N	5785.00
10 kVAr	QHSTMF5010X0	Champion 525 V 50 Hz-10 kVAr 3 PH	1 N	1 N	7712.00
12.5 kVAr	QHSTMF5012X5	Champion 525 V 50 Hz-12.5 kVAr 3 PH	1 N	1 N	9641.00
15 kVAr	QHSTMF5015X0	Champion 525 V 50 Hz-15 kVAr 3 PH	1 N	1 N	11568.00
20 kVAr	QHSTMF5020X0	Champion 525 V 50 Hz-20 kVAr 3 PH	1 N	1 N	15425.00
25 kVAr	QHSTMF5025X0	Champion 525 V 50 Hz-25 kVAr 3 PH	1 N	1 N	19280.00
30 kVAr	QHSTMF5030X0	Champion 525 V 50 Hz-30 kVAr 3 PH	1 N	1 N	24165.00
50 kVAr	QHSTMF5050X0	Champion 525 V 50 Hz-50 kVAr 3 PH	1 N	1 N	40273.00
60 kVAr	QHSTMF5060X0	Champion 525 V 50 Hz-60 kVAr 3 PH	1 N	1 N	48327.00

Other Ratings on request

Effective from 11th March, 2024

(IS: 13340)

List Price (LP) are in Indian ₹ & as per Standard Terms & Conditions

**HAVELLS** 86

## Harmonic Detuned Reactor

### Range:

- 1 kVAr to 100 kVAr
- Available in: Copper & Aluminium
- Detuning Factor: 5.67%, 7% and 14% corresponding to tuning Frequencies of 210 Hz, 190 Hz and 135 Hz for the base of 50 Hz
- Rated Voltage: 380 V to 690 V
- linearity : 185% to 225% of In

### Features:

- High linearity 185% to 225%
- Insulation Class H
- Temperature protection - NC contact (UL Approved)
- Long expected life time
- Low noise & very low losses
- Compliance to IEC 61558



### Selection Chart: Capacitor voltage and kVAr selection for 5.67%, 7% and 14% reactors

Effective kVAr output	With 5.67% detuned reactor		With 7% detuned reactor		With 14% detuned reactor	
	Reactor (440V)	Capacitor (480V)**	Reactor (440V)	Capacitor (480V)**	Reactor (440V)	Capacitor (525V)**
5 kVAr	5 kVAr	6 kVAr/480V	5 kVAr	6 kVAr/480V	5 kVAr	6 kVAr/525V
10 kVAr	10 kVAr	12.5 kVAr/480V	10 kVAr	12.5 kVAr/480V	10 kVAr	12.5 kVAr/525V
12.5 kVAr	12.5 kVAr	15 kVAr/480V	12.5 kVAr	15 kVAr/480V	12.5 kVAr	15 kVAr/525V
15 kVAr	15 kVAr	20 kVAr/480V	15 kVAr	20 kVAr/480V	15 kVAr	20 kVAr/525V
20 kVAr	20 kVAr	25 kVAr/480V	20 kVAr	25 kVAr/480V	20 kVAr	25 kVAr/525V
25 kVAr	25 kVAr	30 kVAr/480V	25 kVAr	30 kVAr/480V	25 kVAr	30 kVAr/525V
50 kVAr	50 kVAr	60 kVAr/480V	50 kVAr	60 kVAr/480V	50 kVAr	60 kVAr/525V
75 kVAr	75 kVAr	90 kVAr/480V	75 kVAr	90 kVAr/480V	75 kVAr	90 kVAr/525V
100 kVAr	100 kVAr	120 kVAr/480V	100 kVAr	120 kVAr/480V	100 kVAr	120 kVAr/525V



## Harmonic Detuned Reactor Aluminium

HSN Code: 85049090

Rating kVAr	Cat. Code	Description	Per Unit LP (₹)
<b>Rated Voltage 440 Vac, F = 50 Hz, P = 7% ( Fr = 189 Hz) / Linearity: L &gt; 0.95 Lr for current up to 1.85 . I1 (Aluminium)</b>			
1 kVAr	QHLLTCV001X0	H. D.- REACTOR, 7% AL, 01 kVAr 440 Vac	5665.00
2 kVAr	QHLLTCV002X0	H. D.- REACTOR, 7% AL, 02 kVAr 440 Vac	6179.00
3 kVAr	QHLLTCV003X0	H. D.- REACTOR, 7% AL, 03 kVAr 440 Vac	6999.00
4 kVAr	QHLLTCV004X0	H. D.- REACTOR, 7% AL, 04 kVAr 440 Vac	7441.00
5 kVAr	QHLLTCV005X0	H. D.- REACTOR, 7% AL, 05 kVAr 440 Vac	9176.00
10 kVAr	QHLLTCV010X0	H. D.- REACTOR, 7% AL, 10 kVAr 440 Vac	11161.00
12.5 kVAr	QHLLTCV012X5	H. D.- REACTOR, 7% AL, 12.5 kVAr 440 Vac	11409.00
15 kVAr	QHLLTCV015X0	H. D.- REACTOR, 7% AL, 15 kVAr 440 Vac	16244.00
20 kVAr	QHLLTCV020X0	H. D.- REACTOR, 7% AL, 20 kVAr 440 Vac	17858.00
25 kVAr	QHLLTCV025X0	H. D.- REACTOR, 7% AL, 25 kVAr 440 Vac	18476.00
50 kVAr	QHLLTCV050X0	H. D.- REACTOR, 7% AL, 50 kVAr 440 Vac	29500.00
75 kVAr	QHLLTCV075X0	H. D.- REACTOR, 7% AL, 75 kVAr 440 Vac	48858.00
100 kVAr	QHLLTCV100X0	H. D.- REACTOR, 7% AL, 100 kVAr 440 Vac	55803.00
<b>Rated Voltage 440 Vac, F = 50 Hz, P = 14% ( Fr = 189 Hz) / Linearity: L &gt; 0.95 Lr for current up to 1.85 . I1 (Aluminium)</b>			
5 kVAr	QHLLTCW005X0	H. D.- REACTOR, 14% AL, 05 kVAr 440 Vac	Price on Request
10 kVAr	QHLLTCW010X0	H. D.- REACTOR, 14% AL, 10 kVAr 440 Vac	
12.5 kVAr	QHLLTCW012X5	H. D.- REACTOR, 14% AL, 12.5 kVAr 440 Vac	
15 kVAr	QHLLTCW015X0	H. D.- REACTOR, 14% AL, 15 kVAr 440 Vac	
20 kVAr	QHLLTCW020X0	H. D.- REACTOR, 14% AL, 20 kVAr 440 Vac	
25 kVAr	QHLLTCW025X0	H. D.- REACTOR, 14% AL, 25 kVAr 440 Vac	
50 kVAr	QHLLTCW050X0	H. D.- REACTOR, 14% AL, 50 kVAr 440 Vac	
75 kVAr	QHLLTCW075X0	H. D.- REACTOR, 14% AL, 75 kVAr 440 Vac	
100 kVAr	QHLLTCW100X0	H. D.- REACTOR, 14% AL, 100 kVAr 440 Vac	

## Harmonic Detuned Reactor Copper

HSN Code: 85049090

Rating kVAr	Cat. Code	Description	Per Unit LP (₹)
<b>Rated Voltage 440 Vac, F = 50 Hz, P = 7% ( Fr = 133 Hz) / Linearity: L &gt; 0.95 Lr for current up to 1.85 . I1, (Copper)</b>			
1 kVAr	QHCTLCV001X0	H. D.- REACTOR, 7% CU, 01 kVAr 440 Vac	7807.00
2 kVAr	QHCTLCV002X0	H. D.- REACTOR, 7% CU, 02 kVAr 440 Vac	8525.00
3 kVAr	QHCTLCV003X0	H. D.- REACTOR, 7% CU, 03 kVAr 440 Vac	9664.00
4 kVAr	QHCTLCV004X0	H. D.- REACTOR, 7% CU, 04 kVAr 440 Vac	10272.00
5 kVAr	QHCTLCV005X0	H. D.- REACTOR, 7% CU, 05 kVAr 440 Vac	11973.00
10 kVAr	QHCTLCV010X0	H. D.- REACTOR, 7% CU, 10 kVAr 440 Vac	16737.00
12.5 kVAr	QHCTLCV012X5	H. D.- REACTOR, 7% CU, 12.5 kVAr 440 Vac	17215.00
15 kVAr	QHCTLCV015X0	H. D.- REACTOR, 7% CU, 15 kVAr 440 Vac	24675.00
20 kVAr	QHCTLCV020X0	H. D.- REACTOR, 7% CU, 20 kVAr 440 Vac	25539.00
25 kVAr	QHCTLCV025X0	H. D.- REACTOR, 7% CU, 25 kVAr 440 Vac	26023.00
50 kVAr	QHCTLCV050X0	H. D.- REACTOR, 7% CU, 50 kVAr 440 Vac	39251.00
75 kVAr	QHCTLCV075X0	H. D.- REACTOR, 7% CU, 75 kVAr 440 Vac	64735.00
100 kVAr	QHCTLCV100X0	H. D.- REACTOR, 7% CU, 100 kVAr 440 Vac	83199.00
<b>Rated Voltage 440 Vac, F = 50 Hz, P = 14% ( Fr = 189 Hz) / Linearity: L &gt; 0.95 Lr for current up to 1.85 . I1 (Copper)</b>			
5 kVAr	QHCTLCW005X0	H. D.- REACTOR, 14% CU, 05 kVAr 440 Vac	Price on Request
10 kVAr	QHCTLCW010X0	H. D.- REACTOR, 14% CU, 10 kVAr 440 Vac	
12.5 kVAr	QHCTLCW012X5	H. D.- REACTOR, 14% CU, 12.5 kVAr 440 Vac	
15 kVAr	QHCTLCW015X0	H. D.- REACTOR, 14% CU, 15 kVAr 440 Vac	
20 kVAr	QHCTLCW020X0	H. D.- REACTOR, 14% CU, 20 kVAr 440 Vac	
25 kVAr	QHCTLCW025X0	H. D.- REACTOR, 14% CU, 25 kVAr 440 Vac	
50 kVAr	QHCTLCW050X0	H. D.- REACTOR, 14% CU, 50 kVAr 440 Vac	
75 kVAr	QHCTLCW075X0	H. D.- REACTOR, 14% CU, 75 kVAr 440 Vac	
100 kVAr	QHCTLCW100X0	H. D.- REACTOR, 14% CU, 100 kVAr 440 Vac	

# Intelligent Power Factor Controller

IEC: 61010-1

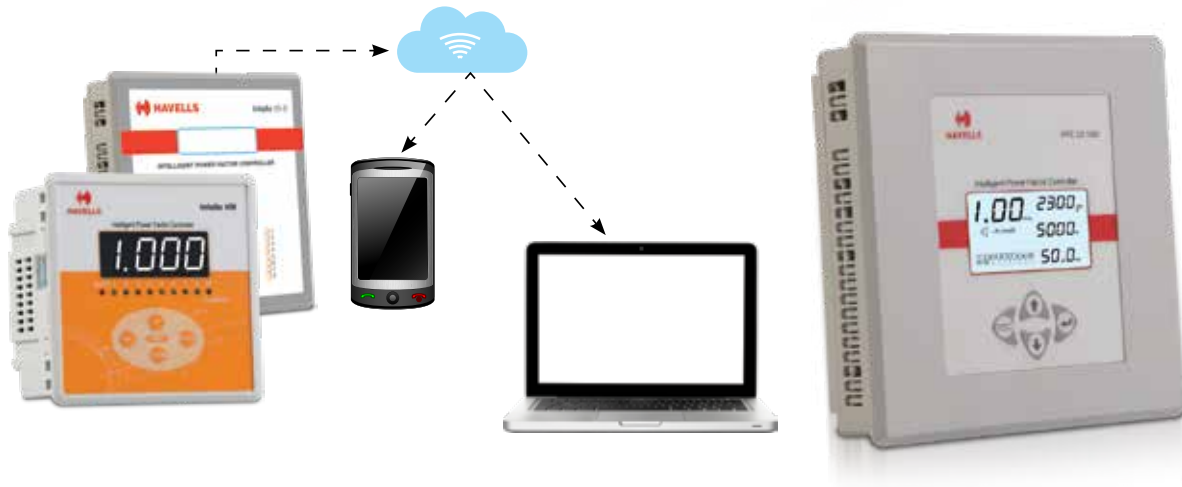

## Range:

- 08 and 12 Steps
- 7 segment LED display
- Size: 144 mm x 144 mm

## Features:

- LCD Type with dual colour backlight
- Auxiliary supply 90 Vac - 550 Vac
- Dual Password Protection
- Automatic CT Polarity detection
- NTC Temperature Sensor
- Communication Interface RS 485 & ModBus RTU (Only for 12 Relay option)
- Power Factor Measurement Range: 0.8 lag to 0.8 lead
- Advance Micro-Controller based logic
- Data logging facility (optional)

HSN Code: 85364900

Steps	Item Code	Description	Standard Pack No of unit/s	Master Pack No of unit/s	Per Unit LP (₹)
Intelligent Power Factor Controller (IPFC CS- 1001) 1 CT					
8	QHOSBS5D0008	IPFC CS 96 x 96	1 N	5 N	7,084.00
8	QHOSBS5N0008	IPFC CS 144 x 144	1 N	5 N	11701.00
12	QHOSBS5N0012	IPFC CS 1001-112-90 V / 550 Vac 144 x 144	1 N	5 N	13585.00
Intelligent Power Factor Controller (IPFC CS- 1003) 3 CT					
8	QHOTBS5H0008	IPFC CS 1001-112-90 V / 550 Vac 144 x 144	1 N	5 N	18760.00
12	QHOTBS5H0012	IPFC CS 1003-312-90 V / 550 Vac 144 x 144	1 N	5 N	23402.00

## Capacitor Switching Solutions

- Fast Switching Speed
- High power handling capacity
- Low losses
- Reliability and longevity
- Real time power factor correction



## Thyristor Switch

HSN Code: 85371000

Cat. Code	Description	Per Unit LP (₹)
QHZCF00111	Thyristor Switch 15 kVAr	31,725.00
QHZCF00121	Thyristor Switch 25 kVAr	36,200.00
QHZCF00131	Thyristor Switch 50 kVAr	43,525.00
QHZCF00141	Thyristor Switch 100 kVAr	65,500.00

Note: For fast Switching Load

Other Ratings on request

**89 HAVELLS** Effective from 11th March, 2024

List Price (LP) are in Indian ₹ & as per Standard Terms & Conditions

# Magnetic Contactor

## Capacitor Duty Contactor

### Features:

- Range : 3 kVAr to 66 kVAr
- De-latching Type design of Resistor Switching Block
- Low VA Burden Wide operating band coils with Class H Insulation
- Common accessories with HGS Range
- High Operating Frequency - 240 Operations per hour
- Handle high inrush current capability
- Utilization category AC-6b
- Finger proof IP20 terminals

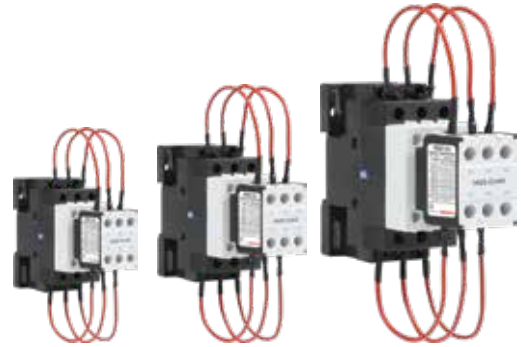

HSN Code: 85369090

Frame Size	kVAr Rating AC-6b	Inst. Aux. Contact		Item Code	Per Unit LP (₹)
	415 V / 440 V	NO	NC		
1	3 kVAr	1	0	IHPHE003110*	2522.00
	3 kVAr	0	1	IHPHE003101*	2522.00
	5 kVAr	1	0	IHPHE005110*	2646.00
	5 kVAr	0	1	IHPHE005101*	2646.00
	10 kVAr	1	0	IHPHE010110*	3204.00
	10 kVAr	0	1	IHPHE010101*	3204.00
	12.5 kVAr	1	0	IHPHE12X110*	3619.00
	12.5 kVAr	0	1	IHPHE12X101*	3619.00
	15 kVAr	1	0	IHPHE015110*	4431.00
	15 kVAr	0	1	IHPHE015101*	4431.00
2	20 kVAr	1	0	IHPHE020210*	4871.00
	20 kVAr	0	1	IHPHE020201*	4871.00
	25 kVAr	1	0	IHPHE025210*	5556.00
	25 kVAr	0	1	IHPHE025201*	5556.00
	33.3 kVAr	1	0	IHPHE33X210*	8052.00
	33.3 kVAr	0	1	IHPHE33X201*	8052.00
3	33.3 kVAr	1	1	IHPHE33X311*	9711.00
	40 kVAr	2	2	IHPHE040322*	14926.00
4	50 kVAr	2	2	IHPHE050422*	15529.00
	66 kVAr	2	2	IHPHE066422*	18223.00

\*To complete the Cat no. suffix the coil voltage from the coil voltage table

33.3 kVAr contactor in Frame-3 can be used where higher terminal capacity is required.

## Coil Voltage Selection Table (3)

3 kVAr - 66 kVAr AC Coil

Product	24 Vac	110 Vac	240 Vac	150 Vac-300 Vac	260 Vac-440 Vac	415 Vac
HGS Capacitor Duty Contactor (3 kVAr - 66 kVArA)	B	H	N	S*	W	T

\*upto 33.3 kVAr for AC - 6B



**HAVELLS**

Install Havells APFC Panel  
&  
**SAVE** Money by reducing kVAh

**Why pay more**  
due to low Power Factor

Is there still a difference in kVAh and kWh in your Electricity Bill due to Low Power Factor?

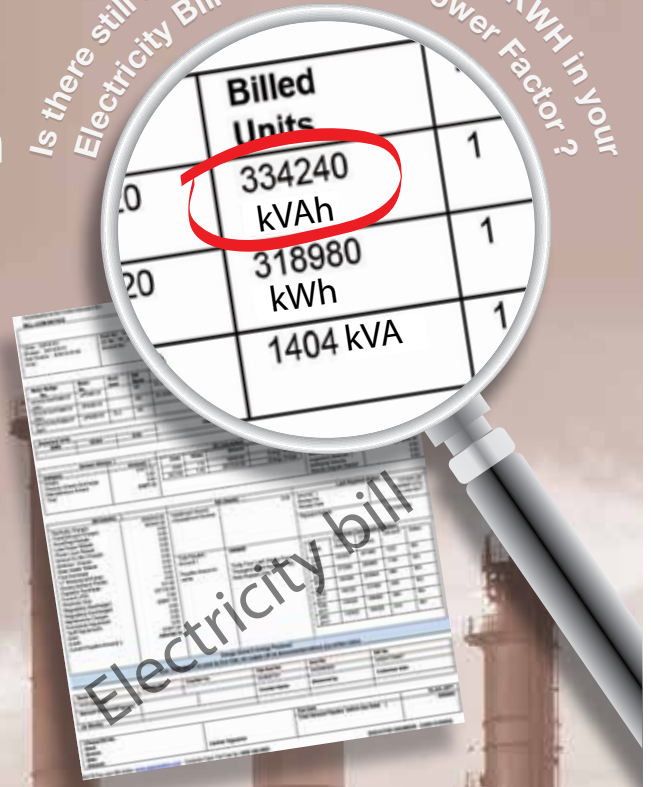

# Smarty - Automatic Power Factor Correction Panel

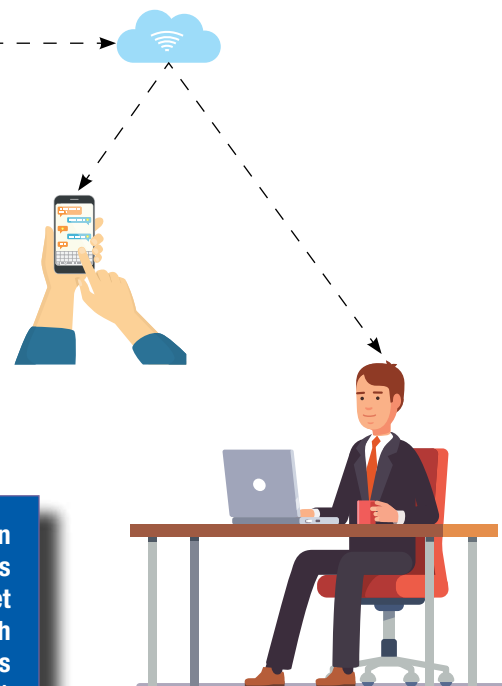

## Range

- ▶ Output Rating: 10 kVAR - 350 kVAR as a standard SKU
- ▶ Other ratings 350 kVAR above on request
- ▶ Switching: Contactor / Thyristorised (Ultra Fast)
- ▶ APFC with Thyristor available on request

## Features

- ▶ Ergonomic, compact and robust design
- ▶ Designed with Fully copper conductor
- ▶ Super Heavy Duty Capacitor power capacitor for long life
- ▶ Advance C-MOS technology based micro processor relay for intelligent power factor control
- ▶ Air core reactor for extra safety from inrush current (High currents)
- ▶ Automatic temp. control through fans and louvers in panel

## Construction

- ▶ Manufactured with highly precise modern Amada CNC machine
- ▶ 11 tank process for corrosion proof powder coating
- ▶ Provision of top and bottom cable entry
- ▶ Double side earthing connection
- ▶ IP 30 & above as per customer demand
- ▶ Ref. Standard: IS 16636 / IEC 61439

## Principle Operation

- ▶ To continuously sense and monitor the load conditions by the use of the external CT (whose output is fed to the control relay).
- ▶ To automatically switch ON and switch OFF relevant capacitor steps to ensure consistent power factor.
- ▶ To ensure easy user interface for enabling reliable understanding of system operation, such as display of real time power factor, number of switching operations carried out etc.
- ▶ To protect against any electrical faults in a manner that will ensure safe isolation of the power factor correction equipment.

# Smarty - Automatic Power Factor Correction Panel

IEC: 61921 / IS: 16636

## APFC Panel without Reactor

HSN Code: 85371000

Rating kVAr	Cat. Code	Description	Main Incomer	Per Unit LP (₹)
<b>Rated Voltage 415 Vac, 3ø, 50 Hz, Delta Connection, Super Heavy Duty Cylindrical Capacitor</b>				
10 kVAr	QHXTCB5010X0	10 kVAr / 415 V APFC Panel CYCAP	MCB 40A / 10 KA	65,000.00
15 kVAr	QHXTCB5015X0	15 kVAr / 415 V APFC Panel CYCAP	MCB 40A / 10 KA	75,000.00
20 kVAr	QHXTCB5020X0	20 kVAr / 415 V APFC Panel CYCAP	MCB 40A / 10 KA	81,000.00
25 kVAr	QHXTCB5025X0	25 kVAr / 415 V APFC Panel CYCAP	MCB 63A / 10 KA	90,500.00
30 kVAr	QHXTCB5030X0	30 kVAr / 415 V APFC Panel CYCAP	MCB 63A / 10 KA	1,08,000.00
40 kVAr	QHXTCB5040X0	40 kVAr / 415 V APFC Panel CYCAP	MCCB 100A / 25 KA	1,47,188.00
50 kVAr	QHXTCB5050X0	50 kVAr / 415 V APFC Panel CYCAP	MCCB 100A / 25 KA	1,65,800.00
75 kVAr	QHXTCB5075X0	75 kVAr / 415 V APFC Panel CYCAP	MCCB 160A / 25 KA	2,45,000.00
80 kVAr	QHXTCB5080X0	80 kVAr / 415 V APFC Panel CYCAP	MCCB 160A / 25 KA	2,60,500.00
100 kVAr	QHXTCB5100X0	100 kVAr / 415 V APFC Panel CYCAP	MCCB 160A / 25 KA	2,85,500.00
125 kVAr	QHXTCB5125X0	125 kVAr / 415 V APFC Panel CYCAP	MCCB 250A / 25 KA	3,95,000.00
150 kVAr	QHXTCB5150X0	150 kVAr / 415 V APFC Panel CYCAP	MCCB 320A / 35 KA	4,49,500.00
175 kVAr	QHXTCB5175X0	175 kVAr / 415 V APFC Panel CYCAP	MCCB 320A / 35 KA	4,97,000.00
200 kVAr	QHXTCB5200X0	200 kVAr / 415 V APFC Panel CYCAP	MCCB 400A / 35 KA	5,69,700.00
225 kVAr	QHXTCB5225X0	225 kVAr / 415 V APFC Panel CYCAP	MCCB 400A / 35 KA	6,40,912.00
250 kVAr	QHXTCB5250X0	250 kVAr / 415 V APFC Panel CYCAP	MCCB 500A / 35 KA	7,05,700.00
275 kVAr	QHXTCB5275X0	275 kVAr / 415 V APFC Panel CYCAP	MCCB 500A / 50 KA	7,75,890.00
300 kVAr	QHXTCB5300X0	300 kVAr / 415 V APFC Panel CYCAP	MCCB 630A / 50 KA	8,15,000.00
325 kVAr	QHXTCB5325X0	325 kVAr / 415 V APFC Panel CYCAP	MCCB 630A / 50 KA	8,82,916.00
350 kVAr	QHXTCB5350X0	350 kVAr / 415 V APFC Panel CYCAP	MCCB 630A / 50 KA	9,17,500.00

\* for Higher rating please contact our branch office

## APFC Technical Details

Rating kVAr	Stages	Dimensions HeightXWidthXDepth (mm)
<b>Rated Voltage 415 Vac, 3ø, 50 Hz, Delta Connection, Super Heavy Duty Cylindrical Capacitor</b>		
10 kVAr	2x1 kVAr + 4x2 kVAr	650x600x200
15 kVAr	2x4 kVAr + 3x2 kVAr + 1x1 kVAr	650x600x200
20 kVAr	2x5 kVAr + 2x3 kVAr + 2x2 kVAr	650x600x200
25 kVAr	4x5 kVAr + 1x3 kVAr + 1x2 kVAr	650x600x200
30 kVAr	1x10 kVAr + 3x5 kVAr + 1x3 kVAr + 1x2 kVAr	900x600x200
40 kVAr	2x12.5 kVAr + 2x5 kVAr + 1x3 kVAr + 1x2 kVAr	900x600x200
50 kVAr	3x12.5 kVAr + 1x7.5 kVAr + 1x3 kVAr + 1x2 kVAr	900x600x200
75 kVAr	2x20 kVAr + 2x10 kVAr + 2x5 kVAr + 1x3 kVAr + 1x2 kVAr	1100x700x250
80 kVAr	2x20 kVAr + 2x12.5 kVAr + 2x5 kVAr + 1x3 kVAr + 1x2 kVAr	1100x700x250
100 kVAr	4x20 kVAr + 1x10 kVAr + 1x5 kVAr + 1x3 kVAr + 1x2 kVAr	1100x700x250
125 kVAr	1x50 kVAr + 2x25 kVAr + 1x10 kVAr + 2x5 kVAr + 1x3 kVAr + 1x2 kVAr	1175x800x540
150 kVAr	2x50 kVAr + 1x25 kVAr + 1x10 kVAr + 2x5 kVAr + 1x3 kVAr + 1x2 kVAr	1175x800x540
175 kVAr	2x50 kVAr + 2x25 kVAr + 1x10 kVAr + 3x5 kVAr	1175x800x540
200 kVAr	3x50 kVAr + 1x25 kVAr + 1x10 kVAr + 3x5 kVAr	1175x800x540
225 kVAr	3x50 kVAr + 2x25 kVAr + 2x10 kVAr + 1x5 kVAr	1175x800x540
250 kVAr	4x50 kVAr + 1x25 kVAr + 2x10 kVAr + 1x5 kVAr	1175x800x540
275 kVAr	1x100 kVAr + 2x50 kVAr + 2x25 kVAr + 2x10 kVAr + 1x5 kVAr	1675x1200x700
300 kVAr	1x100 kVAr + 3x50 kVAr + 1x25 kVAr + 2x10 kVAr + 1x5 kVAr	1675x1200x700
325 kVAr	2x100 kVAr + 1x50 kVAr + 2x25 kVAr + 2x10 kVAr + 1x5 kVAr	1675x1200x700
350 kVAr	2x100 kVAr + 2x50 kVAr + 1x25 kVAr + 2x10 kVAr + 1x5 kVAr	1675x1200x700

## APFC Panel with Detuned Reactor / Thyristor Switching

Rating kVAr	Cat. Code	Description	Per Unit LP (₹)
10 kVAr - 1000 kVAr		10 kVAr -1000 kVAr APFC Panel	Price on Request

# Active Harmonic Filter



Rating in Ampere	Cat No.	Description	Per Unit MRP (₹)
50 A	On Request	50 A / 415 AHF Panel	On Request
75 A		75 A / 415 AHF Panel	
100 A		100 A / 415 AHF Panel	
125 A		125 A / 415 AHF Panel	
150 A		150 A / 415 AHF Panel	
200 A		200 A / 415 AHF Panel	
250 A		250 A / 415 AHF Panel	
300 A		300 A / 415 AHF Panel	
400 A		400 A / 415 AHF Panel	
500 A		500 A / 415 AHF Panel	

## SVG (Static Var Generator)

Rating kVAr	Cat. Code	Description	Per Unit LP (₹)
50 kVAr - 1000 kVAr		50 kVAr - 1000 kVAr SVG Panel	Price on Request

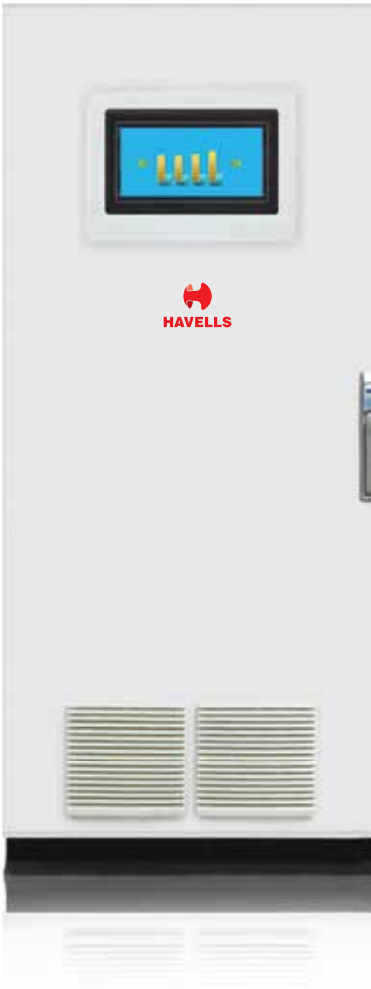

## IEEE 519-2014 Guidelines for Harmonics Limits

Table 2 - Current distortion limits for systems rated 120 V through 69 kV

Maximum harmonic current distortion in percent of $I_L$						
Individual harmonic order (odd harmonics) <sup>a, b</sup>						
$I_h/I_L$	$3 \leq h < 11$	$11 \leq h < 17$	$17 \leq h < 23$	$23 \leq h < 35$	$35 \leq h \leq 50$	TDD
<20	4.0	2.0	1.5	0.6	0.3	5.0
20<50	7.0	3.5	2.5	1.0	0.5	8.0
50<100	10.0	4.5	4.0	1.5	0.7	12.0
100<1000	12.0	5.5	5.0	2.0	1.0	15.0
>1000	15.0	7.0	6.0	2.5	1.4	20.0

## AHF Technical

System Connection	3 P / 4 W or 3 P / 4 W
Input Voltage	415 V (+/-10%) and 50 Hz (+/-)5% other rating on request
Phase compensation current range	15 A - 1000 A (other ratings on request)
Technology	Two Level Topology / Three Level Topology
Harmonic filtration range	2nd to 51st order
Individual harmonic selection	Available
Power factor compensation	100% (Lead / Lag)
Load Balancing	Negative Sequence Compensation (Zero Sequence compensation in 3 P / 4 W range)
Neutral Current Compensation	Available
Reaction time	<0.3 ms
Interface (Communication)	GSM, MODBUS RTU, USB, Ethernet, Profibus Compatible
IP Protection Class	IP-30 and higher on request
System Cooling	Forced air cooling
Overheating Protection	Yes
Relative Humidity	96% (Non condensing)
Ambient Temperature	No deration upto 50 °C



## Active Harmonic Filter & SVG (Static Var Generator)

### Range:

- Rating: 50 A - 500 A

### AHF Technology & Innovation

- Heavy Duty IGBT used for Switching Technology
- Advanced LCD display with intelligent 32 bit microprocessor.
- User friendly programs and customization as per customer requirement for data display.
- Modular design enclosure fabricated by latest Amada CNC Machines & painted through fully automatic powder coating plant after 11 tank process.

### AHF Features:

- The Havells make AHF is a unique innovation solution for Power Quality that address all power quality issues effectively. Major features are:
- Ultra- fast response
- No deration up-to 50 °C ambient temperature
- Havells unique Quad Pro feature- These features enables user to program AHF as per its priority for following compensation :
  - Current harmonics
  - Reactive compensation
  - Load balancing
  - Neutral compensation
- Priority selection feature for maximum capacity utilization as per the system requirement.

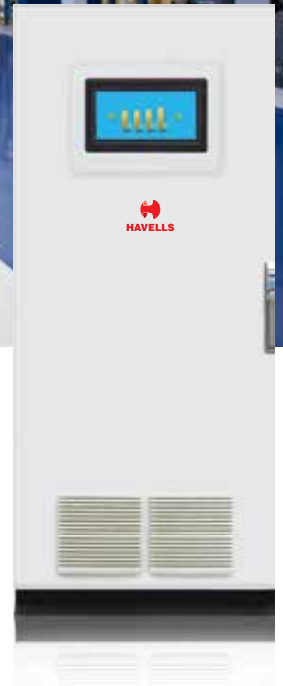

Compliance  
IEEE-519



Printing Press



Pharmaceutical



Data Center

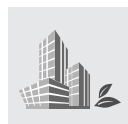

IT Park



Automobiles



Textiles

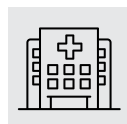

Hospitals



Airports

# Consulting, Optimizing & Delivering Performance

## Power Quality Audit Scope

- Capturing load profile of all relevant sections (with non linear loads) starting with the PCC.
- Checking effectiveness of installed Reactive power compensation system
- Identify zones of failures harmonic.
- Study electricity bills and identify scope of optimization in energy consumption pattern.

## Final Deliverables

- A summary of various electrical parameters & recorded trends.
- Analysis of above data mentioning Key high lights
- Recommended Solution address the various power quality issues identified
- Estimate Potential Saving - Estimate the direct savings and provide ROI calculation (wherever applicable).



# Agriculture Duty Capacitor



- Range : 1 kVAr to 15 kVAr
- Voltage 415 V
- MPP SH, Resin Vielled
- Low Watt loss

## Agri Boost Cylindrical Capacitors for Agriculture Applications

HSN Code: 85321000

Rating kVAr	Item Code	Description	Standard Pack No of unit/s	Master Pack No of unit/s	Per Unit LP (₹)
<b>Rated Voltage 415 Vac, 3φ, 50 Hz, Delta Connection</b>					
1 kVAr	QHATCB5001X0	AGRI BOOST <sup>™</sup> 415 V 50 Hz-1 kVAr 3 PH	1 N	16 N	<b>350.00</b>
2 kVAr	QHATCB5002X0	AGRI BOOST <sup>™</sup> 415 V 50 Hz-2 kVAr 3 PH	1 N	16 N	<b>395.00</b>
3 kVAr	QHATCB5003X0	AGRI BOOST <sup>™</sup> 415 V 50 Hz-3 kVAr 3 PH	1 N	16 N	<b>575.00</b>
4 kVAr	QHATCB5004X0	AGRI BOOST <sup>™</sup> 415 V 50 Hz-4 kVAr 3 PH	1 N	16 N	<b>710.00</b>
5 kVAr	QHATCB5005X0	AGRI BOOST <sup>™</sup> 415 V 50 Hz-5 kVAr 3 PH	1 N	16 N	<b>858.00</b>
6 kVAr	QHATCB5006X0	AGRI BOOST <sup>™</sup> 415 V 50 Hz-6 kVAr 3 PH	1 N	16 N	<b>1030.00</b>
7.5 kVAr	QHATCB5007X5	AGRI BOOST <sup>™</sup> 415 V 50 Hz-7.5 kVAr 3 PH	1 N	16 N	<b>1287.00</b>
8 kVAr	QHATCB5008X0	AGRI BOOST <sup>™</sup> 415 V 50 Hz-8 kVAr 3 PH	1 N	16 N	<b>1372.00</b>
10 kVAr	QHATCB5010X0	AGRI BOOST <sup>™</sup> 415 V 50 Hz-10 kVAr 3 PH	1 N	16 N	<b>1715.00</b>
12.5 kVAr	QHATCB5012X5	AGRI BOOST <sup>™</sup> 415 V 50 Hz-12.5 kVAr 3 PH	1 N	8 N	<b>2145.00</b>
15 kVAr	QHATCB5015X0	AGRI BOOST <sup>™</sup> 415 V 50 Hz-15 kVAr 3 PH	1 N	8 N	<b>2573.00</b>

(IS: 13340)





## Range of Products



Air Circuit Breaker



Moulded Case Circuit Breaker



InstaShift Changeover Switch



Switch Disconnecter Fuse



HRC Fuse



Panel Board



HGS Contactors



HGS Motor Starters



Street Light Panel



Power Capacitors



IPFC Relay



Smarty APFC & Active Harmonic Filter Panel

### REGIONAL & BRANCH OFFICES:

**NORTH - REGIONAL OFFICE:** Corporate Office: QRG Towers, 2D, Sector-126, Expressway, Noida-201304, Tel: 0120-3331000, Delhi: 011-47676700, 23888200, Chandigarh: 0172-4232400-401, Dehradun: 0135-6670202, Haldwani: 05946-222935/222933, Noida / Haryana: 0120-3331000, Ludhiana: 0161-4676000/24, Amritsar: 0183-5202400/401, Jammu: 0191-2478330, 2479330, Sri Nagar: 0194-2459248, Jaipur: 0141-4211000, 4211011, Jodhpur: 9214201640/41, Lucknow: 0522- 4921600/4921649, Kanpur: 0512-6710400

**EAST - REGIONAL OFFICE:** Kolkata: ICC Tower, 5th Floor, 4 India Exchange Place, Kolkata-700001, Tel: 033-40129851/52, Bhubaneswar: 0674-6668101/102/103/104, Guwahati: 0361-2458923, 2134521, Siliguri: 0353-2525907, Ranchi: 0651-2244861, 2244862, 2244864, 2244868, 2244869, Jamshedpur: 0657-6542492, 09234369436, Patna: 0612-2207221, 2207222, 2207223, 2655518

**WEST - REGIONAL OFFICE:** 1271, Solitaire Corporate Park, Bldg. No. 12, 7th Floor, Andheri - Ghatkopar Link Road, Chakala, Andheri (East), Mumbai- 400093. Tel: 022 - 67298600-602, Ahmedabad: 079-40061111, 40060738/740, Indore: 0731-4219444/4219422, 0731-2572340, Rajkot: 0281-2481112, 2921212, Nagpur: 0712-2240932, 2242692, 2242699 Pune: 020-26056175-76, Raipur: 0771-4243400/01, Surat: 0261-2350137, 9979890137, Jabalpur: 0761-4064491, Bhopal: 0755-4271544, 0755-4011025,

**SOUTH - REGIONAL OFFICE:** Chennai: Sigapi Achi Building, No. 18 / 3, 6th Floor, Rukmani Lakshmi pathy Road, Egmore, Chennai-600008, Tel: 044-42280600, 605, Bangalore: 080-49075000, Coimbatore: 0422-4550200/282, Hyderabad: 040-27533372, 27533355, 27533632, Cochin: 0484-4099000, Calicut: 0495-4019193/4/5, Trivandrum: 0471-4015323, Vizag: 0891-6514339, Vijayawada: 0866-2546161/62/67/68/69, Madurai: 0452-4267000, Hubli: 0836-4248660, Trichy: 0431-4041005/06

Representative Offices: • Goa • Solapur • Gwalior • Kathmandu • Bhopal • Kolapur • Vadodara

### Warranty Policy:

All the products listed in the price list carry a warranty, against manufacturing defects for a period of 18\* months from the date of purchase / 12 months from the date of commissioning, whichever is earlier.

\*Proof of purchase to be retained to avail warranty.

### Terms & Conditions

- Prices are in Indian ₹
- This Price List supersedes all our previous Price Lists.
- Prices are subject to change without notice.
- Company reserves the right to issue amendments, which may arise due to any errors in the price list.

Actual products may vary in colour, design, description and colour combination etc. Although every effort has been made to ensure accuracy in the compilation of the technical detail within this publication. Specifications & performance data are constantly changing.

“Copyright Subsists. Imitation of trade dress, graphics and color scheme of this document is a punishable offence.”

Note: All Products to be billed at 18% \*GST (Subject to change as per Govt. Notification).

Scan the QR Code  
to download  
Havells mCatalogue



### Havells India Ltd.

Corp Office: QRG Towers, 2D, Sector-126, Expressway, Noida-201304 (U.P.)

Ph. +91-120-3331000, Email: marketing@havells.com, www.havells.com

Customer Care No.: 08045 77 1313

Join us on Facebook at [www.facebook.com/havells](http://www.facebook.com/havells) and share your ways to save planet!

CIN - L31900DL1983PLC016304



# HAVELLS